

# R&D Automotive

16 Tivoli Street

Albany NY 12207

Phone: 518-598-1273

Fax: 518.598.1275

BavarianRocketScience@gmail.com

BavarianRocketScience.com

Repair Shop 7036352

## INVOICE

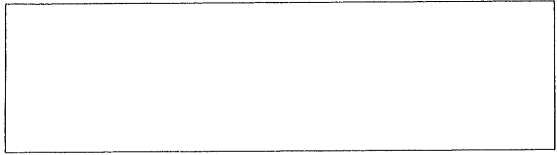

22108  
10/18/2019

Key #:  
Date In: 9/19/19  
Time In: 11:09AM

Completed: 9/19/19  
Cust.#: 1158

Lic# FXT 4493 Veh ID:  
2006 PORSCHE 911 Carrera 2S/Ca  
VIN: WP0AB29916S740570 3.8  
Odometer In: Out:  
Inspection Due: 8/07/2020 Hrs:  
Home:

PO Nbr:

Item	Qty/Time	Description	Price/Rate	Amount
PARTS				
LABOR				
8	1.00	PORSCHE LABOR - PPI	125.00	125.00 1 2

Total Parts:				
Total Labor:	125.00	CASH	aid With	135.00
Total Sublet:				
			Sub Total:	125.00
			Sales Tax	10.00

Writer: 1

Invoice Amount: **135.00**

Ref/Ser:

Less Deposits:

Contact Ph:

**Balance Due:**

# R&D Automotive

16 Tivoli Street

Albany NY 12207

Phone: 518-598-1273

Fax: 518.598.1275

BavarianRocketScience@gmail.com

BavarianRocketScience.com

Repair Shop 7036352

## INVOICE

Item	Qty/Time	Description	Price/Rate	Amount
------	----------	-------------	------------	--------

CUSTOMER PPI- OVERALL VEHICLE IS IN VERY GOOD SHAPE, NO RUST OR SIGNS OF CORROSION, PASSES NEW YORK SAFETY AND EMISSIONS INSPECTION. NO FAULT CODES PRESENT IN DME. NO RECENT OVER REVS PRESENT IN UPPER RANGES. TEST DRIVE - TRANSMISSION SHIFTS SMOOTH AND CLUTCH ENGAGES CORRECTLY WITH NO SLIPPAGE. ENGINE PULLS STRONG, NO SMOKE ON START UP OR UNDER LOAD. NO NOISES OUT OF ORDINARY

- SCUFF ON RIGHT FRONT AND LEFT REAR OF UNDERTRAY OF FRONT BUMPER - MINOR - CLEAR BRA ON HOOD, BUMPER, MIRRORS AND DOOR EDGES, ALL IN GOOD SHAPE - PAINT OVERALL IN VERY GOOD CONDITION, NO SIGNS OF MAJOR ACCIDENTS OR MAJOR PAINT WORK, MINOR SCUFFS ON UNDERSIDE OF CAR

- LEFT FRONT MUD FLAP TORN, BOTH FRONT RUBBER AIR DEFLECTORS DAMAGED, RECOMMEND REPLACEMENT - ALL MINOR, TYPICAL OF DAILY DRIVER CONDITION

- FRONT TIRES DATED 2016, AT 40%, SHOW SLIGHT CAMBER WEAR ON INSIDE EDGES (TYPICAL), REAR TIRES ARE NEW, REPLACED 9/19 - RECOMMEND NEW FRONT TIRES EVENTUALLY DEPENDING ON USAGE. ALIGNMENT CHECK/ADJUSTMENT SHOULD BE DONE AT THAT TIME

- CLIMATE CONTROL BUTTONS SHOW PAINT WORN, RECOMMEND REPLACING - ADAPTIVE SPORT SEATS, DRIVER'S SEAT BOLTERS SHOW CREASES FROM AGE, NO TEARS OR RIPS, ALL FUNCTIONS OPERATE PROPERLY

- AFTERMARKET FITTED TRUNK LINER PRESENT, TOOL KIT APPEARS COMPLETE - FRONT HOOD STRUTS ARE TIRED, RECOMMEND REPLACEMENT - UPGRADED ALUMINUM GAS CAP PRESENT

- ONE PLASTIC COVER IS MISSING FROM LOWER WINDSEILD COWL, VERY MINOR, COSMETIC ONLY - ALL GLASS APPEARS OEM WITH PORSCHE SYMBOL PRESENT, MINOR TRIM PIECE MISSING FROM REAR VIEW MIRROR/RAIN SENSOR - HEAD LIGHT LENSES IN GOOD SHAPE, ALL LIGHTS WORK PROPERLY

- ENGINE COMPARTMENT IS VERY CLEAN, BELTS IN GOOD SHAPE, NO SIGNS OF OIL OR COOLANT LEAKS FROM TOP OR BOTTOM

- REARWARD MOST ENGINE/TRANSMISSION PLASTIC COVER UNDER CAR MISSING, MINOR BUT SUGGEST REPLACING

- LEFT REAR BUMPERETTE HAS MINOR 1 INCH SCRATCH - NURBURGRING DECAL ON RIGHT REAR OF BUMPER

- ONE KEY PRESENT AT TIME OF INSPECTION, TAPED TOGETHER BUT ALL BUTTONS FUNCTION PROPERLY

- FRONT AND REAR BRAKES AT ROUGHLY 70% LIFE LEFT

SUMMARY OF SERVICES PERFORMED:

- 12/1/15 - 35,039 MILES, LUBE, OIL AND FILTER REPLACEMENT, REMOVE FRONT BUMPER TO CLEAN RADIATORS AND AC CONDENSORS OF DEBRIS

- 8/8/16 - 38,290 MILES, WATERPUMP, THERMOSTAT, DRIVE BELT REPLACED, COOLANT FLUSHED

- 12/9/16 - 41,357 MILES, IGNITION COILS AND SPARK PLUGS REPLACED, LUBE, OIL AND FILTER REPLACEMENT

- 4/28/17 - 41,549 MILES, SEND OUT ALL FOUR WHEELS FOR REFURBISHMENT, FOUR WHEEL ALIGNMENT PERFORMED

- 10/02/17 - 46,291 MILES, REPLACE DRIVERS DOOR LOCK ASSEMBLY, CLEAN ROOF DRAINS

- 1/26/18 - 47,426 MILES, CLUTCH AND FLYWHEEL REPLACEMENT, LUBE, OIL AND FILTER REPLACEMENT, CLEAN FRONT RADIATORS OF DEBRIS, RESEAL WINDSHEILD AT FRONT DRIVERS A-PILLAR

- 8/13/18 - 50,496 MILES, REATTACH WINDSHEILD WASHER NOZZLE HOSES

- 8/23/19 - 54,039 MILES, LUBE, OIL AND FILTER REPLACEMENT, REPLACE TWO REAR TIRES

- 9/19/19 - 54,096 MILES, PRE PURCHASE INSPECTION PERFORMED

- 10/14/19 - 54,192 MILES, VEHICLE TOWNED IN, AVR TEST BATTERY, RECHARGE OVERNIGHT ON TRICKLE, RETESTS OK, REINSTALL JUMP SPIKE IN FUSE PANEL

12 MONTHS OR 12,000 MILE WARRANTY ON NEW PARTS AND LABOR PURCHASED THROUGH R&D AUTOMOTIVE. NO WARRANTY ON USED PARTS OR CUSTOMER SUPPLIED PARTS.

**R&D Automotive**

16 Tivoli Street

Albany NY 12207

Phone: 518-598-1273

Fax: 518.598.1275

BavarianRocketScience@gmail.com

BavarianRocketScience.com

Repair Shop 7036352

**INVOICE**

Item	Qty/Time	Description	Price/Rate	Amount
------	----------	-------------	------------	--------

Signature:

Date:

THANK YOU

Int Order#:

Thank You for Your Business!

**R&D Automotive**

16 Tivoli Street  
Albany NY 12207

Phone: 518-598-1273  
BavarianRocketScience@gmail.com  
BavarianRocketScience.com  
Repair Shop 7036352

Fax: 518.598.1275

**INVOICE**

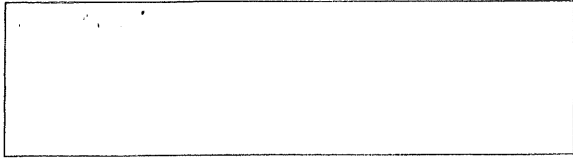

21997  
8/23/2019

Key #:  
Date In: 8/15/19  
Time In: 2:42PM

Completed: 8/23/19  
Cust.#: 1158  
PO Nbr:

Lic# FXT 4493 Veh ID:  
2006 PORSCHE 911 Carrera 2S/Ca  
VIN: WP0AB29916S740570 3.8  
Odometer In: Out: 54,039  
Inspection Due: Hrs:  
Home:  
Ident/Ser#:

Item	Qty/Time	Description	Normal		Your		Amount
			Price/Rate	Price/Rate	Price/Rate	Amount	
<b>PARTS</b>							
99610722553	1.00	OIL FILTER, OX128/1D	31.00				1
0W40	9.00	OIL, MOBIL 1 0W40	12.18				1
HARDWARE	2.00	WHEEL WEIGHTS , VALVE STEMS ETC.		6.00		12.00	1
1890991044	1.00	BRAKE AND PARTS CLEANER		10.00		10.00	1
<b>LABOR</b>							
8	0.80	PORSCHE LABOR - LOF					1
M/B 35 - 45	2.00	MOUNT AND BALANCE TIRE LOW PROFILE AND 19 OR 20 INCH RIMS		35.00		70.00	1
TIRE DISPOSAL	2.00	TIRE DISPOSAL		8.00		16.00	1
NYSI	1.00	NEW YORK STATE INSPECTION CERTIFICATE # 7269422 INSP#236C		21.00		21.00	1

<b>Total Parts:</b>	<b>22.00</b>	<b>VISA</b>	<b>Paid With</b>	<b>137.64</b>	<b>Sub Total:</b>	<b>129.00</b>
<b>Total Labor:</b>	<b>70.00</b>				<b>Sales Tax</b>	<b>8.64</b>
<b>Total Sublet:</b>	<b>37.00</b>					

Writer: 1 Invoice Amount: **137.64**  
Ref/Ser: CC# - Less Deposits:  
Contact Ph: **Balance Due:**

LOF - FILTER ON ITS WAY FROM AUTO PART  
  
MOUNT 2 TIRES ORDERED BY CUSTOMER  
  
NYSI - DONE  
  
12 MONTHS OR 12,000 MILE WARRANTY ON NEW PARTS AND LABOR PURCHASED THROUGH R&D AUTOMOTIVE. NO WARRANTY ON USED PARTS OR CUSTOMER SUPPLIED PARTS.

Signature:  Date:

THANK YOU  
Int Order#: 23740 Thank You for Your Business!

# Advance Auto Parts

Service is our best part.

Store # 06303

911 CENTRAL AVE.

ALBANY NY 12206 (518) 482-1563

07/15/19 15:48 REG 03 TRN# 1719 Adrian S

BATTERY-GOLD 1 EA ATOCF 2130015

48H6 1 \$159.99 \$159.99 T1

36 MO FREE REPL 0 MO PRORATED

2006 Porsche 911

3.8L H6 cid 3824cc

You saved \$5.00

BATTERY-GOLD 1 EA CORE 92130015

48H6 1 \$5.00 \$5.00 T1

BATTERY-GOLD 1 EA CORE 92130015

48H6 -1 \$5.00 \$-5.00

Reason: Core Return

Sub Total \$159.99

T1 Tax @ 8.0000% \$12.80

Total \$172.79

\$172.79 PURCHASE @ 3:49 PM

Visa \*\*\*\*\*7943 CHIP READ

AUTH 07600D Approved REF 630303171901

EMV CARD 1 MERCH 315362 TERM 00000003

**R&D Automotive**

16 Tivoli Street  
Albany NY 12207

Phone: 518-598-1273

Fax: 518.598.1275

BavarianRocketScience@gmail.com

BavarianRocketScience.com

Repair Shop 7036352

**INVOICE**

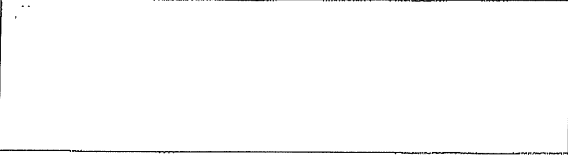

19584  
1/26/2018

Key #:  
Date In: 11/22/17  
Time In: 3:05PM

Completed: 1/26/18  
Cust.#: 1158  
PO Nbr:

Lic# FXT 4493 Veh ID:  
2006 PORSCHE 911 Carrera 2S/Ca  
VIN: WP0AB29916S740570 3.8  
Odometer In: Out: 47,426  
Inspection Due: Hrs:  
Home:

Ident/Ser#:

Item	Qty/Time	Description	Normal Price/Rate	Your Price/Rate	Amount	
<b>PARTS</b>						
999 073 092 02	8.00	FLYWHEEL BOLT		2.29	18.32	1
99711691315	1.00	Clutch Kit	1121.89	890.00	890.00	1
9A7 004 076 00	6.00	Pressure Plate Bolt		0.68	4.08	1
3D1 837 015 C	1.00	Door Latch Ds		185.36	185.36	1
0028009139	3.00	DOOR PANEL CLIP		1.89	5.67	1
MMM08609	1.00	WINDSHIELD URETHANE		32.97	32.97	1
99711401201	1.00	DUAL MASS FLYWHEEL	1253.91	1035.00	1035.00	1
1890991044	1.00	BRAKE AND PARTS CLEANER		10.00	10.00	1
0W40	9.00	OIL, MOBIL 1 0W40		10.95	98.55	1
996 107 225 53	1.00	Oil Filter		28.62	28.62	1
99963103390	1.00	LIGHT BULB LEFT FRONT IN FOG LIGHT ASSEMBLY		7.36	7.36	1
<b>LABOR</b>						
1	10.00	PORSCHE LABOR REPLACE CLUTCH AND FLYWHEEL		95.00	950.00	1
LOF911	0.80	LOF 911/ONE FILTER (.8)		95.00	76.00	1
1	2.00	PORSCHE LABOR - REMOVE FRONT BUMPER COVER TO CLEAN RADIATORS AND A/C CONDENSORS		95.00	190.00	1

<b>Total Parts:</b>	2315.93	<b>Paid With</b>	VISA	1814.48	<b>Sub Total:</b>	3531.93
<b>Total Labor:</b>	1216.00				<b>Sales Tax</b>	282.55
<b>Total Sublet:</b>						

Writer: 1

Invoice Amount: **3814.48**

Ref/Ser:

CC# -

Less Deposits: 2000.00

Contact Ph:

**Balance Due:**

CLUTCH AND FLYWHEEL REPLACEMENT \$2900. AND \$290 TAX
12 MONTHS OR 12,000 MILE WARRANTY ON NEW PARTS AND LABOR. NO WARRANTY ON USED PARTS OR CUSTOMER SUPPLIED PARTS

Signature:

[Signature Box]

Date:

[Date Box]

THANK YOU

Int Order#: 20580

Thank You for Your Business

FXT 4493  
19584

2006 PORSCHE 911 Carrera 2S/Ca

Page 1 Of 1

tl

**R&D Automotive**

16 Tivoli Street  
Albany NY 12207

Phone: 518-598-1273  
BavarianRocketScience@gmail.com  
BavarianRocketScience.com  
Repair Shop 7036352

Fax: 518.598.1275

**WORK ORDER**

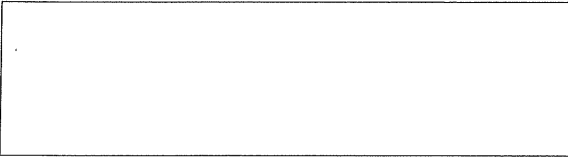

18712  
4/24/2017

Key #:  
Date In: 4/12/17  
Time In: 7:42AM

Cust.#: 1158  
PO Nbr:

Lic# FXT 4493 Veh ID:  
2006 PORSCHE 911  
VIN: WP0AB29916S740570  
Odometer In: Out: 41,549  
Inspection Due: Hrs:  
Home:

Ident/Ser#:

Item	Qty/Time	Description	Normal Price/Rate	Your Price/Rate	Amount	
<b>PARTS</b>						
<b>LABOR</b>						
1	4.00	PORSCHE LABOR FULL WHEEL REPAIR	250.00	200.00	800.00	1
M/B 35 - 45	4.00	MOUNT AND BALANCE TIRE LOW PROFILE AND 19 OR 20 INCH RIM	35.00	35.00	140.00	1
1	3.10	PORSCHE LABOR 4 WHEEL ALIGNMENT	95.00	95.00	294.50	1

Paid With

Total Parts: Sub Total: 1234.50  
Total Labor: 1234.50 Sales Tax 98.76  
Total Sublet:

Writer: 1

Invoice Amount: 1333.26

Ref/Ser:

Less Deposits:

Contact Ph:

**Balance Due: 1333.26**

DROPPED 4/12/2017

M/B 4 TIRES

KEEP OLD TIRES IN CASE

CHECK OVER

HARDWARE USED

ROAD TEST

NOTES

12 MONTHS OR 12,000 MILE WARRANTY ON NEW PARTS AND LABOR. NO WARRANTY ON USED PARTS OR CUSTOMER SUPPLIED PARTS

**Automotive**

16 Tivoli Street  
Albany NY 12207

Phone: 518-598-1273  
BavarianRocketScience@gmail.com  
BavarianRocketScience.com  
Repair Shop 7036352

Fax: 518.598.1275

**INVOICE**

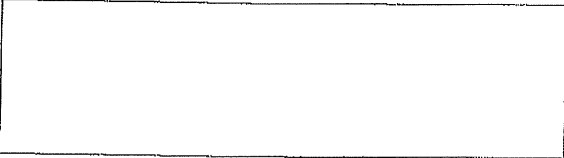

17878  
8/02/2016

Key #:  
Date In: 7/15/16  
Time In: 2:20PM

Completed: 8/02/16  
Cust.#: 1158  
PO Nbr:

Lic# BENNETT Veh ID:  
2006 PORSCHE 911  
VIN: WP0AB29916S740570 D  
Odometer In: Out: 38,290  
Inspection Due: Hrs:  
Home:  
Ident/Ser#:

Item	Qty/Time	Description	Price/Rate	Amount	
<b>PARTS</b>					
997 106 011 06	1.00	Water Pump	435.58	435.58	1
996 106 340 54	1.00	Water Pump Gasket	12.81	12.81	1
996 106 125 53	1.00	Thermostat	85.97	85.97	1
ADK0029P	1.00	Accessory Drive Belt Kit	572.14	572.14	1
997 111 113 00	2.00	EXHAUST GASKET	8.59	17.18	1
HARDWARE	1.00	* Declined * WHEEL WEIGHTS , VALVE STEMS ETC.	7.50		1
1890991044	1.00	* Declined * BRAKE AND PARTS CLEANER	10.00		1
G012A8G1G	4.00	COOLANT/ANTIFREEZE, RED, 1.5 LITER G 012A 8G 1G	23.00	92.00	1
<b>LABOR</b>					
1	6.00	PORSCHE LABOR REPLACE WATER PUMP, THERMOSTAT AND INSTALL BELT KIT	95.00	570.00	1
M/B 35 - 45	4.00	* Declined * MOUNT AND BALANCE TIRE	35.00		1
TIRE DISPOSAL	4.00	* Declined * TIRE DISPOSAL	8.00		1

<b>Total Parts:</b>	1215.68	<b>Paid With</b>	VISA	1928.53	<b>Sub Total:</b>	1785.68
<b>Total Labor:</b>	570.00				<b>Sales Tax</b>	142.85
<b>Total Sublet:</b>						

Writer: 1 Invoice Amount: **1928.53**  
Ref/Ser: CC# - Less Deposits:  
Contact Ph: **Balance Due:**

COOLANT LEAKING OUT OF BACK

NOTES:

12 MONTHS OR 12,000 MILE WARRANTY ON NEW PARTS AND LABOR. NO WARRANTY ON USED PARTS OR CUSTOMER SUPPLIED PARTS

**R&D Automotive**

16 Tivoli Street

Albany NY 12207

Phone: 518-598-1273

Fax: 518.598.1275

BavarianRocketScience@gmail.com

BavarianRocketScience.com

Repair Shop 7036352

**INVOICE**



17151  
11/24/2015

Key #:   
Date In: 11/24/15  
Time In: 7:38AM

Completed: 11/24/15  
Cust.#: 1158  
PO Nbr:

Lic# FXT 4493 Veh ID:  
2006 PORSCHE 911  
VIN: WP0AB29916S740570  
Odometer In: 32,587 Out: 35,303  
Inspection Due: Hrs:  
Home:  
Ident/Ser#:

Item	Qty/Time	Description	Price/Rate	Amount	
<b>PARTS</b>					
996 107 225 53	1.00	Oil Filter Kit - w/ O-Ring	33.18	33.18	1
5W40TOTAL	8.00	OIL, 5W40 TOTAL ENERGY 9000	8.00	64.00	1
<b>LABOR</b>					
LOF911	0.80	LOF 911/ONE FILTER (.8)	95.00	76.00	1
1	2.00	PORSCHE LABOR CLEANED DEBRIS OUT OF FRONT RADIATORS	95.00	190.00	1

<b>Total Parts:</b>	97.18	<b>Paid With</b>			
<b>Total Labor:</b>	266.00	VISA	392.23	<b>Sub Total:</b>	363.18
<b>Total Sublet:</b>				Sales Tax	29.05

Writer: 1

Invoice Amount: **392.23**

Ref/Ser: CC# -

Less Deposits:

Contact Ph:

**Balance Due:**

LOF

CHECK FOR OIL CONSUMPTION TAIL PIPES ARE WET ( OIL ) SUGGEST COMP TEST AND CYLINDER LEAK DOWN TEST

HARDWARE USED

ADDITIONAL REPAIRS PERFORMED

ROAD TEST YES

R.R. TIRE HAS A NAIL IN IT NEEDS TIRES OLD AND DRY ROTTED

BATTERY IS BORDER LINE SHOULD REPLACE IN SPRING

12 MONTHS OR 12,000 MILE WARRANTY ON NEW PARTS AND LABOR. NO WARRANTY ON USED PARTS OR CUSTOMER SUPPLIED PARTS

FXT 4493 2006 PORSCHE 911

tl 17151



QTY. PART NO. AND DESCRIPTION

PRICE

**RENNWERKE LTD.**  
 Porsche Specialists  
 53 Nepperhan Avenue  
 ELMSFORD, NEW YORK 10523  
 (914) 592-4006  
 Facility No. 70993555

12663

NAME	CUSTOMER'S ORDER NO.	DATE
ADDRESS	ORDER WRITTEN BY	PROMISED
CITY, STATE, ZIP	<i>Church</i>	1-8-14
HOME PHONE	BUS. PHONE	EXT.
YEAR, MAKE AND MODEL	2006 997 S coupe	
SERIAL NUMBER	WPOAB29916S74057D	DOOR/TERMINAL NUMBER
		28354
		FHC 2160

DESCRIPTION OF WORK		AMOUNT
<input type="checkbox"/> LUBE	<input type="checkbox"/> CHANGE OIL	
<input type="checkbox"/> OIL FILTER	<input type="checkbox"/> TUNE-UP	
<input type="checkbox"/> TRANS.	<input type="checkbox"/> DIFF.	
<i>CHECK FOR VOLTAGE DRAW</i>		
<i>TEST CHARGING SYSTEM</i>		
<i>&amp; CHECK FOR VOLTAGE DRAW</i>		
<i>DOWNLOAD &amp; REPROGRAM</i>		
<i>ALL CONTROL UNITS.</i>		
<i>PROGRAM &amp; TEST IMMOBILIZER SYSTEM</i>		

ESTIMATED COSTS		TOTAL
PARTS	LABOR	250.00
TOTAL		
I hereby authorize the above repair work to be done along with the necessary materials. You and your employees may operate above vehicle for purposes of testing, inspection, or delivery at my risk. An express mechanics lien is acknowledged on above vehicle to secure the amount of repairs thereto. It is also understood that you will not be held responsible for loss or damage to cars or articles left in cars in case of fire, theft or any other cause beyond your control.		
SIGNATURE		
<input type="checkbox"/> RETURN PARTS <input type="checkbox"/> DISCARD PARTS		
REVISED ESTIMATE/ADDITIONAL WORK		
PARTS	LABOR	250.00
TOTAL		
AUTHORIZED BY	DATE	
TIME	CALLER BY	
TOTAL PARTS		
TOTAL LABOR		250.00
TOTAL PARTS		
SHOP SUPPLIES		
GAS OIL AND GREASE		
SUBLET REPAIRS		
EPA / WASTE DISPOSAL		
TAX		18.44
TOTAL		268.44
THANK YOU		

(MAY BE CONTINUED ON OTHER SIDE)

**RENNWERKE LTD.**  
 Porsche Specialists  
 53 Nepperhan Avenue  
 ELMSFORD, NEW YORK 10523  
 (914) 592-4006  
 Facility No. 7099355

12542

QTY.	PART NO. AND DESCRIPTION	PRICE
1	99610722553 OIL FILTER	29.50
9	99610722553 TOTAL SW40 SYNTEC OIL	88.20
1	99610215166 BELT	58.89
1	99760701903 CABLE	120.97
1	99756424100 SUNROOF	28.84
1	99756424201 SWAGES	28.84
1	99611018152 AIR FILTER	50.94
1	111723 ATE FLUID	30.30
1	99610711856 102CM PULLEY	92.88
1	99610211757 TENSIONER	105.92
1	99610211958 102CM PULLEY	92.92
0	CHECK SUNROOF	
0	REPLACE REMAINING SWAGES	
1	FOR BOTH SIDES	
1	REARER ALL 3	
1	FOR 102CM BARSING PULLEY	
1	FOR DRIVE BELT	
1	CLEAN ALL WATER DRAINS	
1	WASH + ROADTEST	
1	DROPOFF N/C	
TOTAL PARTS		

NAME: \_\_\_\_\_ DATE: 11/13/13  
 ADDRESS: \_\_\_\_\_ PROMISED: A.M. / P.M.  
 CITY, STATE, ZIP: \_\_\_\_\_  
 HOME PHONE: \_\_\_\_\_  
 YEAR, MAKE AND MODEL: 2006 997 coupe S  
 SERIAL NUMBER: WPOAB29916S74057D MOTOR NUMBER: \_\_\_\_\_ TERMS: \_\_\_\_\_  
 BUS. PHONE: \_\_\_\_\_  
 ODOMETER: 28313  
 LICENSE NUMBER: HE2160

**DESCRIPTION OF WORK**

LUBE  CHANGE OIL  OIL FILTER  TUNE-UP  TRANS.  DIFF.  18 mi

CHECK OVER THOROUGHLY  
 SERVICE CHANGE OIL & FILTER  
 REPLACE AIR FILTER  
 FLUSH & BLEED BRAKE HYDRAULICS  
 CHECK FOR VOLTAGE DROP AT ALTERNATOR  
 REPLACE CABLE FROM STARTER TO  
 ALTERNATOR  
 NEW DRIVE BELT

ESTIMATED COSTS		TOTAL LABOR	TOTAL PARTS
PARTS	LABOR	1760.00	728.20
I hereby authorize the above repair work to be done along with the necessary materials. You and your employees may operate above vehicle for purposes of testing, inspection, or delivery at my risk. An express mechanics lien is acknowledged on above vehicle to secure the amount of repairs thereto. It is also understood that you will not be held responsible for loss or damage to cars or articles left in cars in case of fire, theft or any other cause beyond your control.		SHOP SUPPLIES	
SIGNATURE: _____		GAS OIL AND GREASE	
<input type="checkbox"/> RETURN PARTS <input type="checkbox"/> DISCARD PARTS		SUBLET REPAIRS	
REVISED ESTIMATE/ADDITIONAL WORK		EPA / WASTE DISPOSAL	
PARTS	LABOR	2480.20	183.38
AUTHORIZED BY: _____		TAX	
DATE	TIME	TOTAL	2671.
THANK YOU			

(MAY BE CONTINUED ON OTHER SIDE)



**RENNWERKE LTD.**  
 Porsche Specialists  
 53 Nepperhan Avenue  
 ELMSFORD, NEW YORK 10523  
 (914) 592-4006  
 Facility No. 70993355

10745

QTY.	PART NO. AND DESCRIPTION	PRICE
1	99610015703 EXPANSION TANK	184.88
2	000 043 30105 COOLANT	44.00
1	295 30R 17 N1 -498	225.00

NAME	CUSTOMER'S ORDER NO.	DATE PROMISED
ADDRESS	ORDER WRITTEN BY	9-5-12
CITY, STATE, ZIP	<i>Church</i>	A.M. P.M.
HOME PHONE	BUS. P.	
YEAR, MAKE AND MODEL		
SERIAL NUMBER	2006 997-S coupe	COUNTER
VIN	WPOAB29916S740570	26255
	VEHICLE NUMBER	PK-2160
	TERMS	
DESCRIPTION OF WORK		AMOUNT
<input type="checkbox"/> LUBE <input type="checkbox"/> CHANGE OIL <input type="checkbox"/> OIL FILTER <input type="checkbox"/> TUNE-UP <input type="checkbox"/> TRANS. <input type="checkbox"/> DIFF.		
CHECK OPERATION OF STARTER CHECK ALL CONNECTIONS TEST AIR VOLTAGE DRAW TRACE PROBLEM TO BATTERY CUTOFF SWITCH. REMOVE SWITCH FROM SYSTEM DIAGNOSE LOSS OF COOLANT TO OVERFLOW RESERVOIR REPLACE TANK. MOUNT & RANACE 1 MICHAEL TUNE L/R		10@110
ROADTEST RATTLE IN SUN PROOF. LUBRICATE & ADJUST GUIDE RAILS		
ESTIMATED COSTS		
PARTS	LABOR	TOTAL
		1100.00
I hereby authorize the above repair work to be done along with the necessary materials. You and your employees may operate above vehicle for purposes of testing, inspection, or delivery at my risk. An express mechanics lien is acknowledged on above vehicle to secure the amount of repairs thereto. It is also understood that you will not be held responsible for loss or damage to cars or articles left in cars in case of fire, theft or any other cause beyond your control.		423.88
SIGNATURE		
<input type="checkbox"/> RETURN PARTS <input type="checkbox"/> DISCARD PARTS		
REVISED ESTIMATE/ADDITIONAL WORK		
PARTS	LABOR	TOTAL
		1523.88
AUTHORIZED BY		
DATE	TIME	
		112 31.
TOTAL PARTS		1636.19
		THANK YOU

(MAY BE CONTINUED ON OTHER SIDE)



PORSCHE

# The Porsche Multi-Point Inspection Report

The Porsche Multi-Point Inspection Report is a series of thorough vehicle "health checks" performed by factory-trained Porsche technicians. It is designed to keep your Porsche operating in top condition and to minimize your chances of being inconvenienced on the road. If additional service is recommended on any listed item, your Porsche Service Advisor will be happy to speak with you about your options.

Customer Name Jim Lindley Year/Model 06 911 Engine Size 3.6  
 RO/Tag 216885 Mileage 20688 VIN WPOBA299165740570 Date 11/29/10

### Checked and Okay at this Time

#### Check Fluid Levels and Fill

OK FILL	OK FILL
<input checked="" type="checkbox"/> Engine Oil	<input checked="" type="checkbox"/> Brake Reservoir
<input checked="" type="checkbox"/> Windshield Washer	<input checked="" type="checkbox"/> Headlamp Washer
<input checked="" type="checkbox"/> Power Steering	<input checked="" type="checkbox"/> Coolant Recovery Reservoir
<input type="checkbox"/> Transmission (if equipped w/ dipstick)	

#### Check Following Systems / Components

- Operation of horn, interior lights, exterior lamps, turn signals, hazard and brake lamps
- Visually inspect headlamp alignment
- Windshield washer spray, wiper operation and wiper blades
- Windshield cracks and/or chips
- Heating, ventilation and air conditioning check
- Engine air cleaner filter
- Oil and/or fluid leaks
- Constant velocity (CV) drive axle boots (if equipped)
- Exhaust system (leaks, damage, loose parts)
- Steering and steering linkages
- Shocks/struts, air suspension and other suspension components for leaks and/or damage
- Brake system (including lines, hoses and parking brake)
- Engine cooling system, hoses and clamps
- Radiator, heater and air conditioning hoses for leaks / damage
- Accessory drive belt(s)
- Clutch operation (if equipped)
- State inspection due (if applicable) \_\_\_\_\_ / \_\_\_\_\_ / \_\_\_\_\_  
Month Day Year
- Your last completed maintenance 20688 Mileage ; 11/10 Month Year
- Your next factory scheduled maintenance is due at 30,000 Mileage ; 11/11 Month Year

Comments: \_\_\_\_\_

This Courtesy Inspection Completed By Your Porsche Service Team

Service Advisor: \_\_\_\_\_  
 Technician: \_\_\_\_\_  
 Customer Signature: \_\_\_\_\_

### May Require Future Attention

### Requires Immediate Attention

#### Check Battery Condition

Good      Recharge       Bad  
 Comments: \_\_\_\_\_

#### Check Brakes

Measure Front / Rear Brake Linings

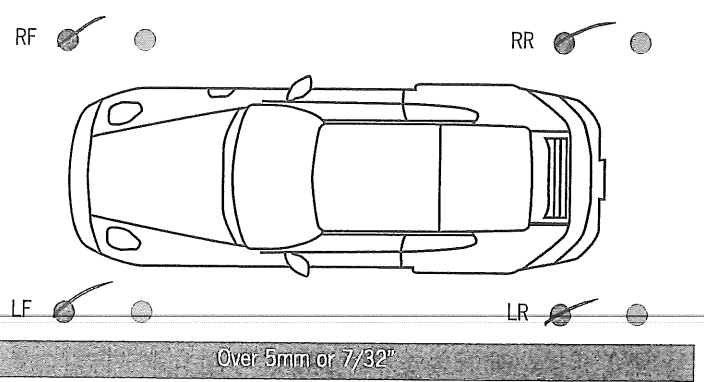

Over 5mm or 7/32"  
 3 to 5mm or 4/32" to 7/32"  
 Less than 3mm or 4/32"

Brake Measurements Not Taken This Service Visit

Comments: \_\_\_\_\_

#### Check Tires

LF	TREAD DEPTH	RF
<input checked="" type="checkbox"/> 7/32" or Greater		<input type="checkbox"/> 7/32" or Greater
<input checked="" type="checkbox"/> 4/32" to 6/32"		<input checked="" type="checkbox"/> 4/32" to 6/32"
<input type="checkbox"/> 3/32" or Less		<input type="checkbox"/> 3/32" or Less
<input checked="" type="checkbox"/> 7/32" or Greater		<input type="checkbox"/> 7/32" or Greater
<input checked="" type="checkbox"/> 4/32" to 6/32"		<input checked="" type="checkbox"/> 4/32" to 6/32"
<input type="checkbox"/> 3/32" or Less		<input type="checkbox"/> 3/32" or Less
LR		RR

LF      Wear Pattern / Damage      RF   
 LR      Tire Wear Indicators      RR

Alignment Check Recommended     Wheel Balance Recommended

Comments: 6-7 mm front tires  
5-6 mm rear tire

Tire Pressure Set to  
 Factory Recommendations    PSI 38 Front    46 Rear

CUSTOMER #: 312433

216885

**FREDB**

FRED BAKER PORSCHE AUDI  
19400 ROCKSIDE ROAD  
BEDFORD OH 44146  
440-232-4700

1940C

Bedfo

440/232-4700

\*INVOICE\*

DUPLICATE 1  
PAGE 1

ID: 00442624  
11/30/10  
Batch #: 557

Ref #: 0006  
09:53:43

**MOTO**

AMEX

\*\*\*\*\*3004M

Appr Code: 163253

Inv#: 013897

Total:

\$ 832.29

Customer Copy  
THANK YOU!

SERVICE ADVISOR: 696 JAC

COLOR	YEAR	MAKE/MODEL	VIN	LICENSE	
SILVER	06	PORSCHE 911	WPOAB29916S740570		
DEL DATE	PROD DATE	WARR EXP	PROMISED	PO NO.	RATE
16SEP05 IS			18:00 29NOV10		115.00
R/O OPENED	READY	OPTIONS: ENG:3.8_Liter			

14:19 29NOV10 17:37 29NOV10

LINE	OPCODE	TECH	TYPE	HOURS	LIST	NET	TOTAL
------	--------	------	------	-------	------	-----	-------

A CHECK OVER FOR SERVICE.SEE JACK.

00 PERFORMED FULL MINOR SERVICE

				133CP115	3.50		402.50	402.50
1	P996-110-131-52	AIR CLEANER	CARTRIDG		49.03	49.03	49.03	49.03
1	P997-571-219-01	CABIN-AIR	FILTER		86.43	86.43	86.43	86.43
1	P996-628-901-08	WIPER	BLADE		55.01	55.01	55.01	55.01
1	P996-107-225-53	OIL-FILTER	INSERT		28.13	28.13	28.13	28.13
9	PMOBILONE	0-W40			11.03	11.03	99.27	99.27
6	P900-123-106-30	ALUM	SEAL RING		1.30	1.30	7.80	7.80
1	EO0144	WASHER	FLUID		4.77	4.77	4.77	4.77
2	B-000-750-M2	BRAKEFLUID			9.03	9.03	18.06	18.06

20688 20K WITH BRAKE FLUSH, FILTERS CHANGE OIL AND FILTER, REPLACE AIR FILTER, REPLACE POLLEN FILTER, REPLACE WIPER BLADES, FLUSH BRAKE FLUID, LUBE DOOR AND LID HINGES, LUBE DOOR AND LID SEALS, CLEAN RADIATOR INTAKES AND FRONT DRAINS, CK LIGHTS, TIRES, BRAKES, SET SERVICE MINDER, TEST DRIVE

\*\*\*\*\*

B NOTE: CUSTOMER SELLING VEH NOTE: NEW CLIENT TO CALL IN

NOTE PERFORMED INSPECTION CHECK OK

133CP115 0.00

15688 0.00 0.00

\*\*\*\*\*

SHOP SUPPLIES

21.43

ON BEHALF OF SERVICING DEALER, I HEREBY CERTIFY THAT THE INFORMATION CONTAINED HEREON IS ACCURATE UNLESS OTHERWISE SHOWN. SERVICES DESCRIBED WERE PERFORMED AT NO CHARGE TO OWNER. THERE WAS NO INDICATION FROM THE APPEARANCE OF THE VEHICLE OR OTHERWISE, THAT ANY PART REPAIRED OR REPLACED UNDER THIS CLAIM HAD BEEN CONNECTED IN ANY WAY WITH ANY ACCIDENT, NEGLIGENCE OR MISUSE. RECORDS SUPPORTING THIS CLAIM ARE AVAILABLE FOR (1) YEAR FROM THE DATE OF PAYMENT NOTIFICATION AT THE SERVICING DEALER FOR INSPECTION BY MANUFACTURER'S REPRESENTATIVE.

Disclaimer of Warranties  
Any warranties on the products sold herein are those made by the manufacturer of those products. Seller hereby expressly disclaims all warranties either express or implied, including any implied warranties of merchantability or fitness for a particular purpose (regarding any products or services provided, unless otherwise indicated on the service repair order). This dealership neither assumes nor authorizes any other person to assume for it any liability in connection with the sale of said products or services. This disclaimer by the dealership in no way affects the terms or performances of the manufacturer's warranty.

DESCRIPTION	TOTALS
LABOR AMOUNT	402.50
PARTS AMOUNT	348.50
GAS, OIL, LUBE	0.00
SUBLET AMOUNT	0.00
MISC. CHARGES	21.43
TOTAL CHARGES	772.43
LESS INSURANCE	0.00
SALES TAX	59.86
PLEASE PAY THIS AMOUNT	832.29

(SIGNED) DEALER, GENERAL MANAGER OR AUTHORIZED PERSON (DATE)

CUSTOMER SIGNATURE

CUSTOMER #: 312433

200435

19400 Rockside Rd.

Bedford, OH 44146

440/232-4700 FAX: 440/232-5354



\*INVOICE\*

PAGE 1

SERVICE ADVISOR: 696 JACK ARNOLD

COLOR	YEAR	MAKE/MODEL	VIN	LICENSE	MILEAGE IN/OUT	TAG	
SILVER	06	PORSCHE 911	WP0AB29916S740570		13307/13328	T805	
DEL DATE	PROD DATE	WARR EXP	PROMISED	PO NO.	RATE	PAYMENT	INV DATE
16SEP05 IS			21:00 14MAR09		115.00	CASH	13MAR09
R.O. OPENED	READY	OPTIONS:					
		ENG:3.8_Liter					
12:25 12MAR09	12:23 13MAR09						

LINE	OPCODE	TECH	TYPE	HOURS	LIST	NET	TOTAL
A PORSCHE L.O.F. MAINTENANCE SERVICE							
911L.O.F. PORSCHE L.O.F. MAINTENANCE SERVICE							
				133CP115	1.50	112.50	112.50
				1 P996-107-225-53 OIL-FILTER INSERT	27.70	27.70	27.70
				1 P900-123-106-30 ALUM SEAL RING	1.22	1.22	1.22
				9 MOBILONE 0-W40	8.55	8.55	76.95
				1 00144 WWF	3.00	3.00	3.00
13310 LOF CHANGE OIL AND FILTR, SET PRES, TOP OFF FLUIDS, LUBE DOOR AND LID HINGES AND LATCHES, LUBE DOOR AND LID SEALS, CLEAN RADIATOR INTAKES AND FRONT DRAINS, SET SERVICE MINDER, CK LIGHTS, TIRES, BRAKES, TEST DRIVE							

B BRAKE FLUID REPLACED							
				47085500 BRAKE FLUID REPLACED			
				133CP115	1.00	115.00	115.00
				2 B-000-750-M2 BRAKEFLUID	9.44	9.44	18.88
13310 FLUSH BRAKE FLUID							

C REMOVE AND SPEED BALANCE 4 WHEELS							
				BAL4 REMOVE AND SPEED BALANCE 4 WHEELS			
				133CP115	1.00	59.95	59.95
13328 BALANCE BALANCE TIRES 2X, INDEX LF FOR BEST RIDE. RR RIM HAS A VERY LIGHT OUT OF ROUNDNESS							

D MISSING FRT TRIM COVERS BY WIPER ARMS							
				S.O.P. ORDER REPLACEMENT PARTS			
				133CP115	0.00	0.00	0.00
				1 P997-572-569-04-FMT COVER CAP. COWL PANE	6.14	6.14	6.14
(PREPAID SPECIAL ORDER PART)							
				1 P997-572-570-04-FMT COVER CAP. COWL PANE	3.05	3.05	3.05
(PREPAID SPECIAL ORDER PART)							
13328 BILLED/ORDERED TRIM PIECES							

E RECALL W737

DESCRIPTION	TOTALS
LABOR AMOUNT	
PARTS AMOUNT	
GAS, OIL, LUBE	
SUBLET AMOUNT	
MISC. CHARGES	
TOTAL CHARGES	
LESS INSURANCE	
SALES TAX	
PLEASE PAY THIS AMOUNT	

ON BEHALF OF SERVICING DEALER, I HEREBY CERTIFY THAT THE INFORMATION CONTAINED HEREON IS ACCURATE UNLESS OTHERWISE SHOWN. SERVICES DESCRIBED WERE PERFORMED AT NO CHARGE TO OWNER. THERE WAS NO INDICATION FROM THE APPEARANCE OF THE VEHICLE OR OTHERWISE, THAT ANY PART REPAIRED OR REPLACED UNDER THIS CLAIM HAD BEEN CONNECTED IN ANY WAY WITH ANY ACCIDENT, NEGLIGENCE OR MISUSE. RECORDS SUPPORTING THIS CLAIM ARE AVAILABLE FOR (1) YEAR FROM THE DATE OF PAYMENT NOTIFICATION AT THE SERVICING DEALER FOR INSPECTION BY MANUFACTURER'S REPRESENTATIVE.

**Disclaimer of Warranties**  
Any warranties on the products sold herein are those made by the manufacturer of those products. Seller hereby expressly disclaims all warranties either express or implied, including any implied warranties of merchantability or fitness for a particular purpose (regarding any products or services provided, unless otherwise indicated on the service repair order). This dealership neither assumes nor authorizes any other person to assume for it any liability in connection with the sale of said products or services. This disclaimer by the dealership in no way affects the terms or performances of the manufacturer's warranty.

(SIGNED) DEALER, GENERAL MANAGER OR AUTHORIZED PERSON (DATE)

CUSTOMER SIGNATURE

87885

95774

**SUNSET IMPORTS**  
**PORSCHE**

\*ACCOUNTING\*

4030 S.W. 139th Way  
 Beaverton, Oregon 97005  
 (503) 641-8600  
 (800) 346-0182  
 www.sunsetimports.com

PAGE 1

SERVICE ADVISOR: 213 DAVID STOUT

COLOUR	YEAR	MAKE/MODEL	VIN	LICENSE	MILEAGE IN/OUT	PLATE	
GT SILVER	06	PORSCHE 997 C2S	WPOAB29916S740570	CU13005	7436/7439	T2317	
DEL DATE	ORIG DATE	WARR EXC	PROMISED	PD NO	RATE	PAYMENT	INV DATE
16SEP05	IS22JUL05	16SEP2009	19:00	08AUG07	0.00	CASH	13AUG07

RENTAL: 08AUG07 - 13AUG07  
 OPTIONS: STK:2178668 DLR:2040 ENG:3.8\_LTR\_355\_HP  
 TRN:6S AXL:U2U2AP

LINE	OPCODE	TECH	TYPE	A/HRS	S/HRS	COST	SALE	COMP	LIST	NET	TOTAL
A 997 20,000/2 YEAR INTERVAL SERVICE \$535.00											
0320997 997 20,000/2 YEAR INTERVAL SERVICE											
\$535.00											
	235	CPC	0.00	3.50	7700	33075				330.75	330.75
	1	996-107-225-53									
		OIL-FILTER INSERT			1126	2027	0	22.52		20.27	20.27
	1	900-103-106-30									
		SEAL RING			20	34	0	0.38		0.34	0.34
	10	MOB040 MOBIL ONE 0/40			4850	7150	0	7.95		7.15	71.50
	1	997-571-219-00									
		CABIN AIR FILTER			4789	6952	0	77.24		69.52	69.52
	1	ZVW-239-003-SP GAS									
		ADDITIVE			196	405	0	4.50		4.05	4.05
	1	ZVW-177-101-SP WASHER									
		SOLVENT			239	495	0	5.50		4.95	4.95
COMPLETED 20K SERVICE											
B 2 YEAR BRAKE FLUID CHANGE \$175.00											
BF 2 YEAR BRAKE FLUID CHANGE \$175.00											
	235	CPC	0.00	1.40	3080	13230				132.30	132.30
	4	ZZZ-PBRFLUID BRAKE									
		FLUID			1200	2248	0	6.25		5.62	22.48
COMPLETED BF											
C C/R INSTALL SOP EXHAUST PARTS											
01 MISCELLANEOUS REPAIR											
	235	CPC	0.00	1.70	3740	16065				160.65	160.65
	1	997-111-105-00 MANIFOLD			23723	27281	0	401.74		272.81	272.81
	1	997-111-106-00 MANIFOLD			23723	27281	0	401.74		272.81	272.81
	2	996-111-107-55 EXHST									
		MANIFLD GASKET			746	858	0	5.75		4.29	8.58
	2	997-111-113-00 EXHAUST									
		GRATING MET			74	430	0	3.45		2.15	4.30
	12	999-075-074-00 HEX									
		HEAD SCREW 8X26			516	588	0	6.67		6.19	5.88
	6	999-084-052-02 LOCKING									

*David*



**STATEMENT OF DISCLAIMER**

Any warranties on the parts and/or accessories sold hereby are those made by the manufacturer. The seller, SUNSET IMPORTS, hereby expressly disclaims all warranties either express or implied, including all implied warranties of merchantability or fitness for a particular purpose, and SUNSET IMPORTS neither assumes nor authorizes any other person to assume for it any liability in connection with the sale of these parts and/or accessories.

**ALL REPAIRS ARE WARRANTED FOR 12 MONTHS OR 12,000 MILES, WHICHEVER OCCURS FIRST.**

CUSTOMER SIGNATURE

DESCRIPTION	TOTALS
LABOR AMOUNT	
PARTS AMOUNT	
GAS, OIL, LUBE	
SUBLET AMOUNT	
SHOP SUPPLIES	
TOTAL CHARGES	
LESS INSURANCE	
MISC. CHARGES	
PLEASE PAY THIS AMOUNT	

87885

9 5 7 7 4

# SUNSET IMPORTS

## PORSCHE

\*ACCOUNTING\*

4030 S.W. 139th Way  
Beaverton, Oregon 97005  
(503) 641-8600  
(800) 346-0182  
www.sunsetimports.com

PAGE 2

SERVICE ADVISOR: 213 DAVID STOUT

COLOR	YEAR	MAKE/MODEL	VIN	LICENSE	MILEAGE IN/OUT	AGE	
GT SILVER	06	PORSCHE 997 C2S	WPOAB29916S740570	CU13005	7436/7439	T2317	
DEL DATE	PROD DATE	WARRANT EXP	PROMISED	PD NO	RATE	PAYMENT	INV DATE
16SEP05	IS22JUL05	16SEP2009	19:00	08AUG07	0.00	CASH	13AUG07

NOV OPENED:      READY:      OPTIONS:    STK:2178668    DLR:2040    ENG:3.8    LTR\_355    HP  
 TRN:6S    AXL:U2U2AP

LINE	OPCODE	TECH	TYPE	A/HRS	S/HRS	COST	SALE	COMP	LIST	NET	TOTAL
NET 8M											
6		900-075-365-02	WHEEL			972	1116	0	3.27	1.86	11.16
6		999-084-052-02	LOCKING			316	384	0	1.19	0.64	3.64
NET 8M											
			INSTALLED			1020	1764	0	3.27	2.94	17.64
MISC ENVIRONMENTAL CHARGE											
			CP			0	200			2.00	2.00
CUSTOMER PAY SHOP SUPPLIES FOR RE											
						0	2000				20.00

ACCOUNT	SALE	COST	CONTROL	ACCOUNT	SALE	COST	CONTROL
44119	62370	14520		48019	68715	57345	
4451	7150	4850		48719	3148	1635	
2202	200	0		4421	2000	0	
1188	143583		30				

**COST, SALE, & COMP TOTALS      78350    143583      0**

### STATEMENT OF DISCLAIMER

Any warranties on the parts and/or accessories sold hereby are those made by the manufacturer. The seller, SUNSET IMPORTS, hereby expressly disclaims all warranties either express or implied, including all implied warranties of merchantability or fitness for a particular purpose, and SUNSET IMPORTS neither assumes nor authorizes any other person to assume for it any liability in connection with the sale of these parts and/or accessories.

**ALL REPAIRS ARE WARRANTED FOR 12 MONTHS OR 12,000 MILES, WHICHEVER OCCURS FIRST.**

CUSTOMER SIGNATURE

DESCRIPTION	TOTALS
LABOR AMOUNT	623.70
PARTS AMOUNT	790.13
GAS, OIL, LUBE	0.00
SUBLET AMOUNT	0.00
SHOP SUPPLIES	22.00
TOTAL CHARGES	1435.83
LESS INSURANCE	0.00
MISC. CHARGES	0.00
PLEASE PAY THIS AMOUNT	1435.83

87885

92820

# SUNSET IMPORTS PORSCHE

ACCOUNTING

4030 S.W. 139th Way  
Beaverton, Oregon 97005  
(503) 641-8600  
(800) 346-0182  
www.sunsetimports.com

PAGE 1

SERVICE ADVISOR: 213 DAVID STOUT

COLOR	YEAR	MAKE/MODEL	VIN	PLATE	MILEAGE	IN	OUT	TAG
GT SILVER	06	PORSCHE 997 C2S	WPOAB299168740570	CU13005	6976/7008			T2260

DEL DATE	RECD DATE	WARRANT	INVOICE	DATE	AMOUNT	PAYMENT	DATE
16SEP05	IS22JUL05	16SEP2009	19:00	31MAY07	0.00	CASH	31MAY07

OPTIONS: STK:2178668 DLR:2040 ENG:3.8\_LTR\_355\_HP  
TRN:6S AXL:U2U2AP

LINE	OPCODE	TECH	TYPE	A/HRS	S/HRS	COST	SALE	COMP	LIST	NET	TOTAL
01											
NOISE FROM AFTER MARKET XM RADIO ANTENNA NO REPAIRS <b>FIXED @ CAR TOUS</b>											
B/C/E RATTLE NOISE FROM DASH OVER ROUGH ROADS <b>TIGARD</b>											
CAUSE: NOISEY											
94051900											
218	WP			0.00	0.40	720	4200			42.00	42.00

FC: 20250400001  
PART#: \_\_\_\_\_  
CLAIM TYPE: 2  
AUTH CODE: \_\_\_\_\_  
720 4200 TLABOR  
REMOVE CLUSTER APPLIED RELY REASSY AND TEST NOISE OK

ACCOUNT	SALE	COST	CONTROL	ACCOUNT	SALE	COST	CONTROL
44119	0	0		44139	4200	720	
4180	0			4200			

6/1/07

## FILE COPY

COST, SALE, & COMP TOTALS 720 4200 0

### STATEMENT OF DISCLAIMER

Any warranties on the parts and/or accessories sold hereby are those made by the manufacturer. The seller, SUNSET IMPORTS, hereby expressly disclaims all warranties either express or implied, including all implied warranties of merchantability or fitness for a particular purpose, and SUNSET IMPORTS neither assumes nor authorizes any other person to assume for it any liability in connection with the sale of these parts and/or accessories.

DESCRIPTION	TOTAL
LABOR AMOUNT	0.00
PARTS AMOUNT	0.00
GAS, OIL, LUBE	0.00
SUBLET AMOUNT	0.00
SHOP SUPPLIES	0.00
TOTAL CHARGES	0.00
LESS INSURANCE	0.00
MISC. CHARGES	0.00
PLEASE PAY THIS AMOUNT	0.00

ALL REPAIRS ARE WARRANTED FOR  
12 MONTHS OR 12,000 MILES,  
WHICHEVER OCCURS FIRST.

CUSTOMER SIGNATURE \_\_\_\_\_

FILE COPY

Will pay 90250

87885

90322

# SUNSET IMPORTS PORSCHE

4030 S.W. 139th Way  
Beaverton, Oregon 97005  
(503) 641-8600  
(800) 346-0182  
www.sunsetimports.com

ACCOUNTING

PAGE 1

SERVICE ADVISOR: 213 DAVID STOUT

GT SILVER	06	PORSCHE 997 C2S	WPOAB29916S740570	CU13005	6570/6570	T894	
DLR DATE	REG DATE	WAR PK	MI	PLATE	PAYMENT	INV DATE	
16SEP05	IS22JUL05	16SEP2009	19:00	05APR07	0.00	CASH	04APR07
OPTIONS: STR:2178668 DLR:2040 ENG:3.8_LTR_355_HP TRN:6S AXL:U2U2AP							

LINE	OPCODE	TECH	TYPE	A/HRS	S/HRS	COST	SALE	COMP	LIST	NET	TOTAL
A/C/E VISIT WORKSHOP IS DISPLAYED											
CAUSE: NO COMMUNICATION											
94195500	FRONT END CONTROL UNIT REPLACED									84.00	84.00
173	WP			0.00	0.80	1520	8400				
1997	610	105	LT CONTROL			18065	25291	0	311.47	252.91	252.91
UNIT. FRONT											
PC: 84160980002											
PART#:											
QTY: 18065 25291 TRAVIS											
CLAIM TYPE: 2											
AUTH CODE:											
1520 8400 TLABOR											

ACCOUNT	SALE	COST	CONTROL	ACCOUNT	SALE	COST	CONTROL
44139	8400	1520		48039	25291	18065	
13329	33691						

## FILE COPY

415107

COST, SALE, & COMP TOTALS 19585 33691 0

### STATEMENT OF DISCLAIMER

Any warranties on the parts and/or accessories sold hereby are those made by the manufacturer. The seller, SUNSET IMPORTS, hereby expressly disclaims all warranties either express or implied, including all implied warranties of merchantability or fitness for a particular purpose, and SUNSET IMPORTS neither assumes nor authorizes any other person to assume for it any liability in connection with the sale of these parts and/or accessories.

DESCRIPTION	AMOUNT
LABOR AMOUNT	0.00
PARTS AMOUNT	0.00
GAS, OIL, LUBE	0.00
SUBLET AMOUNT	0.00
SHOP SUPPLIES	0.00
TOTAL CHARGES	0.00
LESS INSURANCE	0.00
MISC. CHARGES	0.00
PLEASE PAY THIS AMOUNT	0.00

ALL REPAIRS ARE WARRANTED FOR 12 MONTHS OR 12,000 MILES, WHICHEVER OCCURS FIRST.

CUSTOMER SIGNATURE

FILE COPY

87885

90249

# SUNSET IMPORTS

## PORSCHE

\*ACCOUNTING\*

4030 S.W. 139th Way  
Beaverton, Oregon 97005  
(503) 641-8600  
(800) 346-0182  
www.sunsetImports.com

PAGE 1

SERVICE ADVISOR: 213 DAVID STOUT

COLOR	YEAR	MAKE/MODEL	VIN	LICENSE	ODOMETER	TRUCK	
GT SILVER	06	PORSCHE 997 C2S	WP0AB29916S740570	CUL3005	6569/6569	T894	
DEL DATE	PROR DATE	MADE AT	PROMISED	PLNG	RATE	PAYMENT	TRM DATE
16SEP05	1922JUL05	16SEP2009	19:00	03APR07	0.00	CASH	04APR07

REG OPENED: 03APR07      READY: 04APR07

OPTIONS: STK:2178668 DLR:2040 ENG:3.8 LTR\_355\_HP  
TRN:6S AXL:U2U2AP

LINE	OPCODE	TECH	TYPE	A/HRS	S/HRS	COST	SALE	COMP	LIST	NET	TOTAL
EXTERIOR WAX POLISHING OF PAINT. CLEANING AND DRESSING OF MOUNTING BUMPERS, TIRES, WHEELS, AND GLASS. VACUUM AND USE OF HOT WATER EXTRACTOR ON CARPETS AND MATS. CLEAN WINDOWS SPA EXTERIOR WAX POLISHING OF PAINT. CLEANING AND DRESSING OF MOUNTING BUMPERS, TIRES, WHEELS, AND GLASS. VACUUM AND USE OF HOT WATER EXTRACTOR ON CARPETS AND MATS. CLEAN WINDOWS											
				99	CP	6.00	5.00	0	19995	199.95	199.95

COMPLETED SPA

ACCOUNT	SALE	COST	CONTROL	ACCOUNT	SALE	COST	CONTROL
44119	19995	0		1109	19995		80

# FILE COPY

COST, SALE, & COMP TOTALS      0    19995    0

### STATEMENT OF DISCLAIMER

Any warranties on the parts and/or accessories sold hereby are those made by the manufacturer. The seller, SUNSET IMPORTS, hereby expressly disclaims all warranties either express or implied, including all implied warranties of merchantability or fitness for a particular purpose, and SUNSET IMPORTS neither assumes nor authorizes any other person to assume for it any liability in connection with the sale of these parts and/or accessories.

**ALL REPAIRS ARE WARRANTED FOR  
12 MONTHS OR 12,000 MILES,  
WHICHEVER OCCURS FIRST.**

CUSTOMER SIGNATURE

DESCRIPTION	AMOUNT
LABOR AMOUNT	199.95
PARTS AMOUNT	0.00
GAS, OIL, LUBE	0.00
SUBLET AMOUNT	0.00
SHOP SUPPLIES	0.00
TOTAL CHARGES	199.95
LESS INSURANCE	0.00
MISC. CHARGES	0.00
PLEASE PAY THIS AMOUNT	199.95

FILE COPY

87885

90250

# SUNSET IMPORTS

## PORSCHE

4030 S.W. 139th Way  
Beaverton, Oregon 97005  
(503) 641-8800  
(800) 346-0182  
www.sunsetImports.com

ACCOUNTING

PAGE 1

SERVICE ADVISOR: 213 DAVID STOUT

COLOR	YEAR	MAKE	MODEL	VIN	LICENSE	MILEAGE IN	OUT
GT SILVER	06	PORSCHE	997 C2S	WPOAB29916S740570	CU13005	6569/6569	T894
DEL DATE	PROD DATE	WARR EXP	PROMISED	FINC	PAID	PAYMENT	INV DATE
16SEP05	IS22JUL05	16SEP2009	19:00	03APR07	0.00	CASH	04APR07
BIG OPENED		READY	OPTIONS: STK:2178668 DLR:2040 ENG:3.8_LTR_355_HP				
03APR07		04APR07	TRN:6S AXL:U2U2AP				

LINE	OPCODE	TECH	TYPE	A/HRS	S/HRS	COST	SALE	COMP	LIST	NET	TOTAL
A C/S W/ST WORKSHOP IS DISPLAYED											
CAUSE: F											
01 MISCELLANEOUS REPAIR											
173	CP			0.00	0.00	0	0			0.00	0.00

REPLACED FRONT C/S SMD TO P0322  
B C/S BUZZ/RATTLE IS HEARD FROM LEFT DASH AREA OVER ROUGH ROADS

CAUSE: NOISY

68171900	CONSOLE REMOVE+REINSTALL	173	WP	0.00	0.00	1520	84.00			84.00	84.00
68301900	DRINK HOLDER REMOVE+REINSTALL	173	WP	0.00	0.20	380	21.00			21.00	21.00

FC: 68170100001

PARTS COUNT: 0 0 TPARTS

CLAIM TYPE: A

AUTH CODE:

1900 10500 LABOR

FELT TAPE CONTACT POINTS CENTER CONSOLE, AND CUP HOLDER ROAD TEST OK

ACCOUNT	SALE	COST	CONTROL	ACCOUNT	SALE	COST	CONTROL
1188	0	*****	30	13329	10500	*****	

**FILE COPY**

9/5/07

COST, SALE, & COMP TOTALS 1900 10500 0

### STATEMENT OF DISCLAIMER

Any warranties on the parts and/or accessories sold hereby are those made by the manufacturer. The seller, SUNSET IMPORTS, hereby expressly disclaims all warranties either express or implied, including all implied warranties of merchantability or fitness for a particular purpose, and SUNSET IMPORTS neither assumes nor authorizes any other person to assume for it any liability in connection with the sale of these parts and/or accessories.

DESCRIPTION	AMOUNT
LABOR AMOUNT	0.00
PARTS AMOUNT	0.00
GAS, OIL, LUBE	0.00
SUBLET AMOUNT	0.00
SHOP SUPPLIES	0.00
TOTAL CHARGES	0.00
LESS INSURANCE	0.00
MISC. CHARGES	0.00
PLEASE PAY THIS AMOUNT	0.00

ALL REPAIRS ARE WARRANTED FOR 12 MONTHS OR 12,000 MILES, WHICHEVER OCCURS FIRST.

CUSTOMER SIGNATURE

FILE COPY

87885

89429

**SUNSET IMPORTS**

PORSCHE

\*ACCOUNTING\*

4030 S.W. 139th Way  
Beaverton, Oregon 97005  
(503) 641-8800  
(800) 346-0182  
www.sunsetimports.com

DUPLICATE 1  
PAGE 1

SERVICE ADVISOR: 213 DAVID STOUT

COLOR	YEAR	MAKE/TYPE	VIN	LICENSE	INVENTORY	PLAS	
GT SILVER	06	PORSCHE 997 C2S	WP0AB29916S740570	CU13005	6424/6426	T483	
DEL DATE	PRG DATE	WARR EXP	PROMISED	FINC	RATE	PAYMENT	INV DATE
16SEP05	IS22JUL05	16SEP2009	19:00 16MAR07		0.00	CASH	15MAR07

NO. OPENED: 15MAR07      READY: 15MAR07  
 OPTIONS: STK:2178668 DLR:2040 ENG:3.8\_LTR\_355\_HP  
 TRN:6S AXL:U2U2AP

LINE	OPCODE	TECH	TYPE	A/HRS	S/HRS	COST	SALE	COMP	LIST	NET	TOTAL
REPLACE BATTERY SEE JOB FOR SPECIAL PARTS PRICE											
01 MISCELLANEOUS REPAIR											
	218	CP		0.00	0.25	450	2625			26.25	26.25
1 999-611-080-20 DRY BATTERY (NOT HAZ)											
						10368	11923	0	185.14	119.23	119.23
	1	ZZZ-ACID	BATT ACID			100	625	0	6.25	6.25	6.25
27 ENGINE ELECTRICAL											
	218	IP		0.00	0.25	450	2625			26.25	26.25
REPAIRS BATTERY											
MISC ENVIRONMENTAL CHARGE											
		CP				0	200			2.00	2.00

ACCOUNT	SALE	COST	CONTROL	ACCOUNT	SALE	COST	CONTROL
44119	2625	450		48019	11923	10368	
48719	625	100		44159	2625	450	
2202	200	0		1188	15373	*****	30
58019	2625	*****	89429				

**FILE COPY**

COST, SALE, & COMP TOTALS      11368      17998      0

**STATEMENT OF DISCLAIMER**

Any warranties on the parts and/or accessories sold hereby are those made by the manufacturer. The seller, SUNSET IMPORTS, hereby expressly disclaims all warranties either express or implied, including all implied warranties of merchantability or fitness for a particular purpose, and SUNSET IMPORTS neither assumes nor authorizes any other person to assume for it any liability in connection with the sale of these parts and/or accessories.

DESCRIPTION	TOTALS
LABOR AMOUNT	26.25
PARTS AMOUNT	125.48
GAS, OIL, LUBE	0.00
SUBLET AMOUNT	0.00
SHOP SUPPLIES	2.00
TOTAL CHARGES	153.73
LESS INSURANCE	0.00
MISC. CHARGES	0.00
PLEASE PAY THIS AMOUNT	153.73

ALL REPAIRS ARE WARRANTED FOR  
12 MONTHS OR 12,000 MILES,  
WHICHEVER OCCURS FIRST.

CUSTOMER SIGNATURE

FILE COPY

87885

86830

SUNSET  
PORS

ACCOUNTING

4030 S.W. 15  
Beaverton, Oregon  
(503) 641-86  
(800) 346-018  
www.sunsetimports.

PAGE 1

SERVICE ADVISOR: 213 DAVID STOUT

DELOR	YEAR	MAKE/MODEL	VIN	UZE#	MILEAGE IN O/I		
GT SILVER	06	PORSCHE 997 C28	WPOAB29916S740570	CU13005	6319/6319		
DEL DATE	PRD DATE	WARR EX	PROMISED	NO NO	DATE	PAYMENT	BY
16SEP05	IS22JUL05	16SEP2009	19:00	17JAN07	0.00	CASH	18JAN07
H/C OPENED		READY		OPTIONS: STK:2178668 DLR:2040 ENG:3.8_LTR_355_HP			
		TRN:6S AXL:U2U2AP					

LINE	OPCODE	TECH	TYPE	A/HRS	S/HRS	COST	SALE	COMP	LIST	NET	TOTAL
A C/S CONSOLE HAS BLEMISH IN FINISH											
CAUSE: BLEMISH											
	60171900	CONSOLE REMOVED+REINSTAL								84.00	84.00
	173	WP	0.00	0.80	1520	8400					
	1	997-641-800-49	CENTER CONSOLE. ALUM						990.58	990.58	990.58
	FC:	68370150002									
	PART#:	70756 99058 TPARTS									
	COUNT:	2									
	CLAIM TYPE:	2									
	AUTH CODE:	1520 8400 TLABOR									

REPLACED CENTER CONSOLE AND TRANSFERRED COMPONENTS OK  
 B C/S RATTLE FROM GAUGE CLUSTER AREA

CAUSE: RATTLE											
	90251900	INSTRUMENT CLUSTER REMOVED+REINSTD								42.00	42.00
	173	WP	0.00	0.40	760	4200					
	FC:	90250100002									
	PART#:	0 0 TPARTS									
	COUNT:	0									
	CLAIM TYPE:	2									
	AUTH CODE:	760 4200 TLABOR									

R/I INSTRUMENT CLUSTER ADDED FOAM PADDING AND FELT TO CONTACT POINTS  
 C C/S RATTLE FROM RE AREA OF CAR OVER ROUGH ROADS

CAUSE: F											
	01	MISCELLANEOUS REPAIR								0.00	0.00
	173	CP	0.00	0.00	0	0					
NO RATTLES HEARD AT THIS TIME											
D** C/S PASS AIRBAG LIGHT IS LOOSE											
CAUSE: CRACKED											
	69591900	AIRBAG MODULE F PASSENGER REMOVED+REINST								84.00	84.00
	173	WP	0.00	0.80	1520	8400					
	1	997-641-165-00-A05									

STATEMENT OF DISCLAIMER

Any warranties on the parts and/or accessories sold hereby are those made by the manufacturer. The seller, SUNSET IMPORTS, hereby expressly disclaims all warranties either express or implied, including all implied warranties of merchantability or fitness for a particular purpose, and SUNSET IMPORTS neither assumes nor authorizes any other person to assume for it any liability in connection with the sale of these parts and/or accessories.

ALL REPAIRS ARE WARRANTED FOR  
 12 MONTHS OR 12,000 MILES,  
 WHICHEVER OCCURS FIRST.

CUSTOMER SIGNATURE

DESCRIPTION	TOTALS
LABOR AMOUNT	
PARTS AMOUNT	
GAS, OIL, LUBE	
SUBLET AMOUNT	
SHOP SUPPLIES	
TOTAL CHARGES	
LESS INSURANCE	
MISC. CHARGES	
PLEASE PAY THIS AMOUNT	

87885

06507

# SUNSET IMPORTS

PORSCHE

ACCOUNTING

4030 S.W. 139th Way  
Beaverton, Oregon 97005  
(503) 641-8600  
(800) 346-0182  
www.sunsetImports.com

PAGE 1

SERVICE ADVISOR: 144 ROB COSNER

MODEL	YEAR	MAKE/MODEL	VIN	TITLE	MPG	INT/OUT	TAX	
GT SILVER	06	PORSCHE 997 C2S	WPOAB29916S740570	CU13005	6230/6239		T273	
DEL DATE	PROD DATE	WARRANT	REG/REG	REG NO	RATE	PAYMENT	INV DATE	
16SEP05	1622JUL05	16SEP2009	14:30	08JAN07	0.00	CASH	10JAN07	
REG OPENED		READY	OPTIONS: STK:2178668 DLR:2040 ENG:3.8_LTR_355_HP					
08JAN07		10JAN07	TRN:6S AXL:U2U2AP					

LINE	OPCODE	TECH	TYPE	A/HRS	S/HRS	COST	SALE	COMP	LIST	NET	TOTAL
A/C/S PAINT PLAY IN THE CENTER CONSOLE TECH EQUIPMENT											
PO PARTS ORDERED											
	99	00		0.00	0.00	0	0			0.00	0.00

ACCOUNT	SALE	COST	CONTROL	ACCOUNT	SALE	COST	CONTROL
44119	0	0		1108	0		30

# FILE COPY

COST, SALE, & COMP TOTALS 0 0 0

### STATEMENT OF DISCLAIMER

Any warranties on the parts and/or accessories sold hereby are those made by the manufacturer. The seller, SUNSET IMPORTS, hereby expressly disclaims all warranties either express or implied, including all implied warranties of merchantability or fitness for a particular purpose, and SUNSET IMPORTS neither assumes nor authorizes any other person to assume for it any liability in connection with the sale of these parts and/or accessories.

DESCRIPTION	TOTALS
LABOR AMOUNT	0.00
PARTS AMOUNT	0.00
GAS, OIL, LUBE	0.00
SUBLET AMOUNT	0.00
SHOP SUPPLIES	0.00
TOTAL CHARGES	0.00
LESS INSURANCE	0.00
MISC. CHARGES	0.00
PLEASE PAY THIS AMOUNT	0.00

ALL REPAIRS ARE WARRANTED FOR 12 MONTHS OR 12,000 MILES, WHICHEVER OCCURS FIRST.

CUSTOMER SIGNATURE

FILE COPY

87885

00102

**SUNSET IMPORTS**

PORSCHE

\*ACCOUNTING\*

4030 S.W. 139th Way  
Beaverton, Oregon 97005  
(503) 641-8600  
(800) 346-0182  
www.sunsetimports.com

PAGE 1

SERVICE ADVISOR: 213 DAVID STOUT

COLOR	YEAR	MAKE/MODEL	VIN	CHARGE	MILEAGE IN DT	TAX
GT SILVER	06	PORSCHE 997 C2S	WFOAB29916S740570	CU13005	4114/4114	T7831
DEL DATE	FRD DATE	WARR END	PROMISED	DATE	PAYMENT	INV DATE
16SEP05	IS22JUL05	16SEP2009	13:00	05AUG06	0.00	CASH 04AUG06

R.O. OPENED: 02AUG06      READY: 04AUG06  
 OPTIONS: STK:2178668 DLR:2040 ENG:3.8 LTR\_355\_HP  
 TRN:6S AXL:U2U2AP

LINE	OPCODE	TECH	TYPE	A/HRS	S/HRS	COST	SALE	COMP	LIST	NET	TOTAL
A INSPECT AND ADJUST CLUTCH IF NEEDED											
01 MISCELLANEOUS REPAIR											
	27	CP		0.00	0.00	0	0			0.00	0.00
FUNCTION NORMAL AT THIS TIME											
B SOP IN PARTS TO BE INSTALLED/ CONSOLE PIECE											
01 MISCELLANEOUS REPAIR											
	27	CP		0.00	2.50	5563	26250			262.50	262.50
1 997-044-800-40 CENTER CONSOLE ALUM											
						7096	84710	0	948.40	847.10	847.10
MODIFIED AND INSTALLED COUNSEL											
C INSTALL CUSTOMER SUPPLIED 5MM SPACERS											
01 MISCELLANEOUS REPAIR											
	27	CP		0.00	1.00	2225	10500			105.00	105.00
INSTALLED WHEEL SPACERS											
D PLEASE INSTALL FOOT REST (SOP)											
01 MISCELLANEOUS REPAIR											
	27	CP		0.00	0.10	659	1150			31.50	31.50
1 997-551-986-00 FOOTREST											
						14150	16235	0	188.66	162.35	162.35
INSTALLED ROAD PEDAL											
E PLEASE STRAIGHTEN REAR LIC PLATE FRAME											
01 MISCELLANEOUS REPAIR											
	27	CP		0.00	0.00	0	0			0.00	0.00
STRAIGHTENED PLATE FRAME											
MISC ENVIRONMENTAL CHARGE											
		CP				0	200			2.00	2.00
CUSTOMER PAY SHOP SUPPLIES FOR RE											
						0	1995				19.95
ACCOUNT	SALE	COST	CONTROL	ACCOUNT	SALE	COST	CONTROL				
4119	39900	8456		48019	100945	84966					
2202	200	0		4421	1995	0					
1188	143040										

COST, SALE, & COMP TOTALS 93362 143040 0

**STATEMENT OF DISCLAIMER**

Any warranties on the parts and/or accessories sold hereby are those made by the manufacturer. The seller, SUNSET IMPORTS, hereby expressly disclaims all warranties either express or implied, including all implied warranties of merchantability or fitness for a particular purpose, and SUNSET IMPORTS neither assumes nor authorizes any other person to assume for it any liability in connection with the sale of these parts and/or accessories.

ALL REPAIRS ARE WARRANTED FOR 12 MONTHS OR 12,000 MILES, WHICHEVER OCCURS FIRST.

CUSTOMER SIGNATURE

DESCRIPTION	TOTAL
LABOR AMOUNT	399.00
PARTS AMOUNT	1009.45
GAS, OIL, LUBE	0.00
SUBLET AMOUNT	0.00
SHOP SUPPLIES	21.95
TOTAL CHARGES	1430.40
LESS INSURANCE	0.00
MISC. CHARGES	0.00
PLEASE PAY THIS AMOUNT	1430.40

87885

80103

# SUNSET IMPORTS

## PORSCHE

4030 S.W. 139th Way  
Beaverton, Oregon 97005  
(503) 641-8600  
(800) 346-0182  
www.sunsetimports.com

ACCOUNTING

PAGE 1

SERVICE ADVISOR: 213 DAVID STOUT

COLOR	YEAR	MAKE/MODEL	VIN	LICENSE	MILEAGE IN/OUT	TAG	
GT SILVER	06	PORSCHE 997 C2S	WPOAB29916S740570	CU13005	4114/4114	T7831	
DEL DATE	PHG DATE	MARK NEXT	PROG USE	PD NO	RATE	PAYMENT	INV DATE
16SEP05	IS22JUL05	16SEP2009	13:00	03AUG06	0.00	CASH	04AUG06
E.O. OPENED		READY	OPTIONS: STK:2178668 DLR:2040 ENG:3.8_LTR_355_HP				
02AUG06		04AUG06	TRN:6S AXL:U2U2AP				

LINE	OPCODE	TECH	TYPE	A/HRS	S/HRS	COST	SALE	COMP	LIST	NET	TOTAL
A C/S DRIVERS DOOR STILLE ARE BLENDED											
CAUSE:											
01 MISCELLANEOUS REPAIR											
	27	CP		0.00	0.00	0	0			0.00	0.00

ALL OKAY  
B C/S RATTLE NOISE FROM RIGHT FRONT OF CABIN, SEE HISTORY  
CAUSE: NOISEY

68201999	ASHTRAY										
27	WP			0.00	0.50	1113	5250			52.50	52.50
FC: 68200200002											

PARTS  
COUNT: 0 0 TPARTS  
CLAIM TYPE: 2  
AUTH CODE: 1113 5250 TPARTS

REPLACED ASHTRAY WHEN NEW CENTER CONSOLE WAS INSTALLED AS CUSTOMER UPGRADE  
C C/S CLUTCH ENGAGES POORLY, PLEASE INSPECT  
CAUSE:

30	CLUTCH										
27	CP			0.00	0.00	0	0			0.00	0.00

DROVE CAR AND FOUND THAT CLUTCH WAS NORMAL

ACCOUNT	SALE	COST	CONTROL	ACCOUNT	SALE	COST	CONTROL
44119	0	0		44119	5250	1113	
1188	0	*****	30	13329	5250	*****	

44119 (52.50) I BE #27 (1.50)  
Did not repl. C = 11.13  
posted 8/15

COST, SALE, & COMP TOTALS 1113 5250 0

### STATEMENT OF DISCLAIMER

Any warranties on the parts and/or accessories sold hereby are those made by the manufacturer. The seller, SUNSET IMPORTS, hereby expressly disclaims all warranties either express or implied, including all implied warranties of merchantability or fitness for a particular purpose, and SUNSET IMPORTS neither assumes nor authorizes any other person to assume for it any liability in connection with the sale of these parts and/or accessories.

ALL REPAIRS ARE WARRANTED FOR 12 MONTHS OR 12,000 MILES, WHICHEVER OCCURS FIRST.

CUSTOMER SIGNATURE

DESCRIPTION	TOTALS
LABOR AMOUNT	0.00
PARTS AMOUNT	0.00
GAS, OIL, LUBE	0.00
SUBLET AMOUNT	0.00
SHOP SUPPLIES	0.00
TOTAL CHARGES	0.00
LESS INSURANCE	0.00
MISC. CHARGES	0.00
PLEASE PAY THIS AMOUNT	0.00

87885

74694

**SUNSET IMPORTS**  
**PORSCHE**

\*ACCOUNTING\*

4030 S.W. 139th Way  
 Beaverton, Oregon 97005  
 (503) 641-8600  
 (800) 348-0182  
 www.sunsetImports.com

PAGE 1

SERVICE ADVISOR: 130 CHRISTINA WILLIS

COLOR	YEAR	MAKE/MODEL	VIN	PIERS	MILEAGE IN/OUT	PAS		
GT SILVER	06	PORSCHE 997 C2S	WP0AB29916S740570	CU13005	2651/2651	T4301		
DEL DATE	INSP DATE	WANT EXP	FROMISED	FIN NO	RATE	PAYMENT	INSP DATE	
16SEP05	IS22JUL05	16SEP2009	17:00	04APR06	0.00	CASH	04APR06	
B.C. OPENED		READY	OPTIONS: STK:2178668 DLR:2040 ENG:3.8_LTR_355_HP'				TRN:6S AXL:U2U2AP	
29MAR06		04APR06						

LINE	OPCODE	TECH	TYPE	A/HRS	S/HRS	COST	SALE	COMP	LIST	NET	TOTAL
A** SYNTHETIC LUBRICATION, OIL AND FILTER SERVICE USING 0/40 MOBILE											
1 SYNTHETIC											
02S SYNTHETIC LUBRICATION, OIL AND FILTER SERVICE USING 0/40 MOBILE 1 SYNTHETIC											
				1.75	CP	0.00	2.00	3200	21000	110.00	210.00
1 996-107-225-53											
OIL FILTER INSERT											
						1047	2094	0	20.94	20.94	20.94
1 900-123-106-30 ALUM											
SEAL RING											
						19	37	0	0.37	0.37	0.37
10 MOB040 MOBIL ONE 0/40											
						4200	7950	0	7.95	7.95	79.50
5 222-HPNL MISC HARDWARE											
						225	445	0	0.89	0.89	4.45

MISC GAS											
P0#74694											
					CP	1000	1000			10.00	10.00

COMPLETED  
 B\*\* STOP RATTLING DUE TO XM INSTALL

01 MISCELLANEOUS REPAIR											
				27	CP	0.00	1.00	2225	10500	105.00	105.00
R/R MX RADIO APPLIED FELT TO CONTACT POINTS ZEP THE WIPER RR ROAT TEST											

OK											
MISC ENVIRONMENTAL CHARGE											
					CP	0	200			2.00	2.00

CUSTOMER PAY SHOP SUPPLIES FOR RE											
						0	1575				15.75

ACCOUNT	SALE	COST	CONTROL	ACCOUNT	SALE	COST	CONTROL
44119	31500	5425		48019	2131	1066	
4451	7950	1300		48119	445	225	
1474	1000	1000	74694	2202	200	0	
4421	1575	0		1168	44801	0	30

**FILE COPY**

COST, SALE, & COMP TOTALS 11916 44801 0

**STATEMENT OF DISCLAIMER**

Any warranties on the parts and/or accessories sold hereby are those made by the manufacturer. The seller, SUNSET IMPORTS, hereby expressly disclaims all warranties either express or implied, including all implied warranties of merchantability or fitness for a particular purpose, and SUNSET IMPORTS neither assumes nor authorizes any other person to assume for it any liability in connection with the sale of these parts and/or accessories.

ALL REPAIRS ARE WARRANTED FOR  
 12 MONTHS OR 12,000 MILES,  
 WHICHEVER OCCURS FIRST.

CUSTOMER SIGNATURE

DESCRIPTION	TOTALS
LABOR AMOUNT	315.00
PARTS AMOUNT	105.26
GAS, OIL, LUBE	0.00
SUBLET AMOUNT	0.00
SHOP SUPPLIES	27.75
TOTAL CHARGES	448.01
LESS INSURANCE	0.00
MISC. CHARGES	0.00
PLEASE PAY THIS AMOUNT	448.01

FILE COPY

87885

74693

# SUNSET IMPORTS

PORSCHE

ACCOUNTING

4030 S.W. 139th Way  
Beaverton, Oregon 97005  
(503) 641-8600  
(800) 346-0182  
www.sunsetimports.com

PAGE 1

SERVICE ADVISOR: 130 CHRISTINA WILLIS

COLOR	YEAR	MAKE/MODEL	VIN	BUCKET	MILEAGE IN/OUT	TAC	
GT SILVER	06	PORSCHE 997 C2S	WPOAB29916S740570	CU13005	2651/2651	T4301	
DEL DATE	PREP DATE	WASH LOG	PROMISED	PNR	RATE	PAYMENT	INVT DATE
16SEP05	IS22JUL05	16SEP2009	17:00	30MAR06	0.00	CASH	04APR06
RO OPENED		READY	OPTIONS: STR:2178668 DLR:2040 ENG:3.8_LTR_355_HP				
29MAR06		04APR06	TRN:6S AXL:U2U2AP				

LINE	OPCODE	TECH	TYPE	A/HRS	S/HRS	COST	SALE	COMP	LIST	NET	TOTAL
A/C/S THE OUTRER CUP/HOLDER CAPOTES BAWLY PLEASE CHECK **SOP**											
CAUSE: RATTLES											
68101900 REMOVE AND INSTALL CUP HOLDER											
	173	WP		0.00	0.20	320	1900			19.00	19.00
1	997	552	284	00	AS CUP						
	HOLDER					13930	19502	0	224.68	195.02	195.02
PC: 69300180001											
PART#:											
COUNT: 13930 19502 TPARTS											
CLAIM TYPE: 2											
AUTH CODE:											
320 1900 TLABOR											

REPL CUP HOLDER APPLIED FILL TAPE ON B SERVICE ACTION A601-REPLACE BOTH EXHAUST TAILPIPES (SOP-JEFF)

CAUSE: COMPLETED											
A601 SERVICE ACTION A601-REPLACE BOTH EXHAUST TAILPIPES											
	27	WP		0.00	0.60	1335	5700			57.00	57.00
1	997	044	081	00	NAC TAIL						
	PIPE LEFT 997					7106	9948	0	101.52	99.48	99.48 <i>50.00</i>
1	997	044	082	00	NAC TAIL						
	PIPE RIGHT 997					7106	9948	0	101.52	99.48	99.48 <i>50.00</i>
PC: A6010998002											
PART#:											
COUNT: 1335 5700 TPARTS											
CLAIM TYPE: R											
AUTH CODE:											
1335 5700 TLABOR											

C SERVICE ACTION W610-INSTALLING NEW SYSTEM SOFTWARE FOR PCM

CAUSE: COMPLETED											
W610 SERVICE ACTION W610-INSTALLING NEW SYSTEM SOFTWARE FOR PCM											
	27	WP		0.00	0.30	668	2850			28.50	28.50

**STATEMENT OF DISCLAIMER**

Any warranties on the parts and/or accessories sold hereby are those made by the manufacturer. The seller, SUNSET IMPORTS, hereby expressly disclaims all warranties either express or implied, including all implied warranties of merchantability or fitness for a particular purpose, and SUNSET IMPORTS neither assumes nor authorizes any other person to assume for it any liability in connection with the sale of these parts and/or accessories.

ALL REPAIRS ARE WARRANTED FOR 12 MONTHS OR 12,000 MILES, WHICHEVER OCCURS FIRST.

CUSTOMER SIGNATURE

DESCRIPTION	TOTAL
LABOR AMOUNT	
PARTS AMOUNT	
GAS, OIL, LUBE	
SUBLET AMOUNT	
SHOP SUPPLIES	
TOTAL CHARGES	
LESS INSURANCE	
MISC. CHARGES	
PLEASE PAY THIS AMOUNT	

87885

74693

# SUNSET IMPORTS

## PORSCHE

ACCOUNTING

4030 S.W. 139th Way  
Beaverton, Oregon 97005  
(503) 641-8600  
(800) 346-0182  
www.sunsetimports.com

PAGE 2

SERVICE ADVISOR: 130 CHRISTINA WILLIS

CUSTOMER	YEAR	MAKE/MODEL	VIN	BOOKING	MILEAGE IN/OUT	TAG	
GT SILVER	06	PORSCHE 997 C2S	WPOAB29916S740570	CU13005	2651/2651	T4301	
DEL DATE	PRICE DATE	WORK DATE	PROMISED	PDING	DATE	PAYMENT	INVT DATE
16SEP05	IS22JUL05	16SEP2009	17:00	30MAR06	0.00	CASH	04APR06
FC: 95190660001		OPTIONS: STK:2178668 DLR:2040 ENG:3.8 LTR_355_HP		IRN:6S AXL:U2U2AP			

LINE	OPCODE	TECH	TYPE	A/HRS	S/HRS	COST	SALE	COMP	LIST	NET	TOTAL
	FC	95190660001									
PART#: _____											
COUNT: _____											
CLAIM TYPE: R											
AUTH CODE: _____											
						668	2850	TLABOR			

COMPLETED  
 D C/S GLOVE BOX RATTLES ON ROUGH ROADS CANYON/217  
 CAUSE: RATTLES  
 91422000 REMOVE AND INSTALL REAR SPEAKERS

FC: 91420180001											
PART#: _____											
COUNT: _____											
CLAIM TYPE: 2											
AUTH CODE: _____											
						480	2850	TLABOR			

FOUND BOTH REAR SPEAKERS RATTING, R/R REAR SPEAKERS APPLY FELT TAPE TO SPEAKERS AND COVERS DE

ACCOUNT	SALE	COST	CONTROL	ACCOUNT	SALE	COST	CONTROL
44139	13300	2803		48039	39398	28142	
44329	52698						
501.24							

48000 (-) 25.00  
 posted FILE COPY  
 APR 10 PAID  
 41112

COST, SALE, & COMP TOTALS 30945 52698 0

### STATEMENT OF DISCLAIMER

Any warranties on the parts and/or accessories sold hereby are those made by the manufacturer. The seller, SUNSET IMPORTS, hereby expressly disclaims all warranties either express or implied, including all implied warranties of merchantability or fitness for a particular purpose, and SUNSET IMPORTS neither assumes nor authorizes any other person to assume for it any liability in connection with the sale of these parts and/or accessories.

ALL REPAIRS ARE WARRANTED FOR 12 MONTHS OR 12,000 MILES, WHICHEVER OCCURS FIRST.

CUSTOMER SIGNATURE \_\_\_\_\_

DESCRIPTION	TOTALS
LABOR AMOUNT	0.00
PARTS AMOUNT	0.00
GAS, OIL, LUBE	0.00
SUBLET AMOUNT	0.00
SHOP SUPPLIES	0.00
TOTAL CHARGES	0.00
LESS INSURANCE	0.00
MISC. CHARGES	0.00
PLEASE PAY THIS AMOUNT	0.00

87885

69904

**SUNSET IMPORTS**

PORSCHE

\*ACCOUNTING\*

4030 S.W. 139th Way  
Beaverton, Oregon 97005  
(503) 641-8600  
(800) 346-0182  
www.sunsetimports.com

PAGE 1

SERVICE ADVISOR: 144 ROB COSNER

COLOR	YEAR	MAKE/MODEL	VIN	LICENSE	MILEAGE IN/OUT	TAG	
GT SILVER	06	PORSCHE 997 C2S	WPOAB29916S740570		967/967	T4822	
DEL DATE	PROD DATE	WARR EXP	PROMISED	PERIOD	RATE	PAYMENT	INV DATE
16SEP05 IS			17:00 07DEC05		0.00	CASH	08DEC05
B.O. OPENED		READY	OPTIONS: STK:2178668 DLR:2040 ENG:3.8_LTR_355_HP				
07DEC05		08DEC05	TRN:6S AXL:U2U2AP				

LINE	OPCODE	TECH	TYPE	A/HRS	S/HRS	COST	SALE	COMP	LIST	NET	TOTAL
A C/S PLEASE INSTALL NAV-UNIT (90P) COST 100											
01			MISCELLANEOUS REPAIR			14400	85500			855.00	855.00
1			997-044-901-04								
NAVIGATION MONITOR											
1			997-622-701-00 OPTICAL			169102	228216	0	2601.63	2282.16	2282.16
1			997-622-708-00 OPTICAL			10390	13775	0	155.07	137.75	137.75
1			997-622-713-00 OPTICAL			10390	13775	0	155.07	137.75	137.75
1			N-103-358-01 SOCKET			5	8	0	0.08	0.08	0.08

COMPLETED  
B C/S PLEASE TOUCH UP DRIVERS SIDE PAINT MARKS, (POSSIBLE SEAT BELT DAMAGE)

01			MISCELLANEOUS REPAIR			0	0			0.00	0.00
			99 ISPP	0.00	0.00						
PAINT INSIDE VEHICLE											
CUSTOMER PAY SHOP SUPPLIES FOR RE						0	2000				20.00

ACCOUNT	SALE	COST	CONTROL	ACCOUNT	SALE	COST	CONTROL
44119	85500	14400		47369	228216	169102	
48019	41333	31175		44159	0	0	
4421	2000	0		1188	357049	311175	30
6403	0	*****					

COST, SALE, & COMP TOTALS 214677 357049 0

**STATEMENT OF DISCLAIMER**

Any warranties on the parts and/or accessories sold hereby are those made by the manufacturer. The seller, SUNSET IMPORTS, hereby expressly disclaims all warranties either express or implied, including all implied warranties of merchantability or fitness for a particular purpose, and SUNSET IMPORTS neither assumes nor authorizes any other person to assume for it any liability in connection with the sale of these parts and/or accessories.

ALL REPAIRS ARE WARRANTED FOR 12 MONTHS OR 12,000 MILES, WHICHEVER OCCURS FIRST.

CUSTOMER SIGNATURE

DESCRIPTION	TOTALS
LABOR AMOUNT	855.00
PARTS AMOUNT	2695.49
GAS, OIL, LUBE	0.00
SUBLET AMOUNT	0.00
SHOP SUPPLIES	20.00
TOTAL CHARGES	3570.49
LESS INSURANCE	0.00
MISC. CHARGES	0.00
PLEASE PAY THIS AMOUNT	3570.49

87885

69901

# SUNSET IMPORTS

## PORSCHE

ACCOUNTING

4030 S.W. 139th Way  
Beaverton, Oregon 97005  
(503) 841-8600  
(800) 346-0182  
www.sunsetimports.com

PAGE 1

SERVICE ADVISOR: 144 ROB COSNER

COLOR	YEAR	MAKE/MODEL	VIN	LICENSE	MILEAGE IN/OUT	TAG
GT SILVER	06	PORSCHE 997 C2S	WP0AB29916S740570		966/966	T4822
DEL DATE	PROP DATE	WORK EXP	PROMISED	FD NO	DATE	PAYMENT
16SEP05 IS			17:00 07DEC05		0.00	CASH
R.O. ORDERED	READY	OPTIONS: STK:2178668 DLR:2040 ENG:3.8 LTR_355_HP				
		TRN:6S AXL:U2U2AP				
07DEC05	08DEC05					

LINE	OPCODE	TECH	TYPE	A/HRS	S/HRS	COST	SALE	COMP	LIST	NET	TOTAL
A/C/S TUP HOLDER PARTIAL OUTSIDE PASSENGER SIDE											
CAUSE:											
68 BODY ACCESSORIES INTERIOR											
162	CP			0.00	0.00	0	0			0.00	0.00
ORDERED NOISY CHIP HOLDER IT IS ON BACK ORDER WILL NOTIFY CUSTOMER WHEN											
IN											

ACCOUNT	SALE	COST	CONTROL	ACCOUNT	SALE	COST	CONTROL
14119	0	0		148	0	0	0

COST, SALE, & COMP TOTALS 0 0 0

### STATEMENT OF DISCLAIMER

Any warranties on the parts and/or accessories sold hereby are those made by the manufacturer. The seller, SUNSET IMPORTS, hereby expressly disclaims all warranties either express or implied, including all implied warranties of merchantability or fitness for a particular purpose, and SUNSET IMPORTS neither assumes nor authorizes any other person to assume for it any liability in connection with the sale of these parts and/or accessories.

ALL REPAIRS ARE WARRANTED FOR 12 MONTHS OR 12,000 MILES, WHICHEVER OCCURS FIRST.

CUSTOMER SIGNATURE

DESCRIPTION	TOTAL
LABOR AMOUNT	0.00
PARTS AMOUNT	0.00
GAS, OIL, LUBE	0.00
SUBLET AMOUNT	0.00
SHOP SUPPLIES	0.00
TOTAL CHARGES	0.00
LESS INSURANCE	0.00
MISC. CHARGES	0.00
PLEASE PAY THIS AMOUNT	0.00

87885

67119

# SUNSET IMPORTS PORSCHE

ACCOUNTING

4030 S.W. 139th Way  
Beaverton, Oregon 97005  
(503) 641-8600  
(800) 346-0182  
www.sunsetimports.com

PAGE 1

SERVICE ADVISOR: 144 ROB COSNER

COLOR	YEAR	MAKE/MODEL	VIN	LICENSE	MILEAGE IN/OUT	LAB	
GT SILVER	06	PORSCHE 997 C2S	WP0AB29916S740570		273/273	T8541	
DEL DATE	PROD DATE	WARE EXP	PROMISED	DD MO	RATE	PAYMENT	INV DATE
16SEP05 IS			17:00 06OCT05		0.00	CASH	15OCT05
R/O OPENED		READY	OPTIONS: STK:2178668 DLR:2040 ENG:3.8_LTR_355_HP				
04OCT05		07OCT05	TRN:6S AXL:U2U2AP				

LINE	OPCODE	TECH	TYPE	A/HRS	S/HRS	COST	SALE	COMP	LIST	NET	TOTAL
A C/S PLEASE INSTALL DOOR SILLS (SOP)											
70	TRIM-INTERIOR										
	162	CP		0.00	0.75	1200	7125			71.25	71.25
	1	997-044-800-44	ENTRANCE LINING			22690	26094	0	302.53	260.94	260.94
INSTALLED NEW DOOR SILLS											
B C/S PLEASE INSTALL CD PLAYER (SOP)											
27	ENGINE-ELECTRICAL										
	162	CP		0.00	1.50	2400	14250			142.50	142.50
	1	997-044-900-78	CD CHANGER			62125	71448	0	555.85	714.48	714.48
	-1	955-559-037-01-4W9	LOGO			1798	2062	0	25.61	20.62	-20.62
	-1	PNA-506-986	SILVERGLASS CAR COVE			10595	12184	0	169.95	121.84	-121.84
	1	911-095-933-20-M7Z	PAINT TOUCH UP APPLI			1042	1198	0	14.08	11.98	11.98
	1	997-622-712-00	OPTICAL FIBER			10390	11942	0	155.07	119.42	119.42
INSTALLED CD CHANGER											
C C/S THE NAV UNIT NEEDS TO BE INSTALL (SOP)											
27	ENGINE-ELECTRICAL										
	162	CP		0.00	0.00	0	0			0.00	0.00
NO WORK DONE PER CLIENT											
D THE COP HOLDER AREA HAS A RATTLE NOISE, OVER ROUGH ROADS, PLEASE CHECK.											
CAUSE: NOISY											
70	TRIM-INTERIOR										
	162	CP		0.00	0.00	0	0			0.00	0.00
	1	997-552-264-02-1MZ	AS DASHBOARD			3362	33127	0	33.67	33.67	33.67
	1	ZZZ-FRT	SHIPPING CHARGE			0	33.67	0	33.67	33.67	33.67
	1	900-146-611-02	BORER M4 X 10			25	35	0	0.48	0.35	0.35

### STATEMENT OF DISCLAIMER

Any warranties on the parts and/or accessories sold hereby are those made by the manufacturer. The seller, SUNSET IMPORTS, hereby expressly disclaims all warranties either express or implied, including all implied warranties of merchantability or fitness for a particular purpose, and SUNSET IMPORTS neither assumes nor authorizes any other person to assume for it any liability in connection with the sale of these parts and/or accessories.

DESCRIPTION	TOTAL
LABOR AMOUNT	
PARTS AMOUNT	
GAS, OIL, LUBE	
SUBLET AMOUNT	
SHOP SUPPLIES	
TOTAL CHARGES	
LESS INSURANCE	
MISC. CHARGES	
PLEASE PAY THIS AMOUNT	

ALL REPAIRS ARE WARRANTED FOR 12 MONTHS OR 12,000 MILES, WHICHEVER OCCURS FIRST.

CUSTOMER SIGNATURE

87885

67119

# SUNSET IMPORTS

PORSCHE

ACCOUNTING

4030 S.W. 139th Way  
Beaverton, Oregon 97005  
(503) 641-8800  
(800) 346-0182  
www.sunsetimports.com

PAGE 2

SERVICE ADVISOR: 144 ROB COSNER

COLOR	YEAR	MAKE/MODEL	VIN	LICENSE	MILEAGE IN/OUT	TAX	
GT SILVER	06	PORSCHE 997 C2S	WPOAB29916S740570		273/273	T8541	
DEL DATE	PRG DATE	WARD EXP	PROMISED	RD NO	RATE	PAYMENT	INV DATE
16SEP05	IS		17:00	06OCT05	0.00	CASH	15OCT05
H/O OPENED	READY	OPTIONS:					
04OCT05	07OCT05	STK:2178668 DLR:2040 ENG:3.8 LTR 355 HP, TRN:6S AXL:U2U2AP					

LINE	OPCODE	TECH	TYPE	A/HRS	S/HRS	COST	SALE	COMP	LIST	NET	TOTAL
						0	0	0	0	0	0
PADDED SEAT BELT ADJUSTER ON PASSENGER SIDE. REPLACED GLOVE BOX. E C/S THE PASSENGER SIDE FRONT SEAT WILL CHATTER OVER ROUGH ROADS. CAUSE NOISE.											
						0	0	0	0	0.00	0.00
						0	63	0	0.89	0.63	0.63
1	ZZZ-HDWRL	MISC	HARDWARE			45					
						0	0	0	0	0	0

REMOVED SEAT AND FOUND LOOSE WIRE. RESECURED WIRE TO HARNESS ROAD  
TEST; OK.  
MISC ENVIRONMENTAL CHARGE CP 0 200 2.00 2.00  
CUSTOMER PAY SHOP SUPPLIES TOB BE 0 1069 10.69

ACCOUNT	SALE	COST	CONTROL	ACCOUNT	SALE	COST	CONTROL
44119	21375	3600		47369	85358	74224	
48039	11078	9639		6747	3367	0	
48039	47162	33687		13329	50592	*****	
4421	1069	0					
48039	119080	*****			676.91		

44139 - 171.00  
NOT ON RO  
48039 + 01 posted 10.31

COST, SALE, & COMP TOTALS 121195 169672 0

### STATEMENT OF DISCLAIMER

Any warranties on the parts and/or accessories sold hereby are those made by the manufacturer. The seller, SUNSET IMPORTS, hereby expressly disclaims all warranties either express or implied, including all implied warranties of merchantability or fitness for a particular purpose, and SUNSET IMPORTS neither assumes nor authorizes any other person to assume for it any liability in connection with the sale of these parts and/or accessories.

DESCRIPTION	TOTALS
LABOR AMOUNT	213.75
PARTS AMOUNT	964.36
GAS, OIL, LUBE	0.00
SUBLET AMOUNT	0.00
SHOP SUPPLIES	12.69
TOTAL CHARGES	1190.80
LESS INSURANCE	0.00
MISC. CHARGES	0.00
PLEASE PAY THIS AMOUNT	1190.80

ALL REPAIRS ARE WARRANTED FOR  
12 MONTHS OR 12,000 MILES,  
WHICHEVER OCCURS FIRST.

CUSTOMER SIGNATURE

87885

67119

# SUNSET IMPORTS PORSCHE

4030 S.W. 139th Way  
Beaverton, Oregon 97005  
(503) 641-8600  
(800) 346-0182  
www.sunsetimports.com

ACCOUNTING

PAGE 1

SERVICE ADVISOR: 144 ROB COSNER

COLOR	YEAR	MAKE/MODEL	VIN	LICENSE	MILEAGE IN/OUT	TAB
GT SILVER	06	PORSCHE 997 C2S	WPOAB29916S740570		273/273	T8541
DEL DATE	PROD DATE	WARRANT EXT	PROMISED	PAID	RATE	PAYMENT
16SEP05 IS			17:00 06OCT05		0.00	CASH
NO. OPENED	READY	OPTIONS: STK:2178668 DLR:2040 ENG:3.8 LTR_355_HP				
04OCT05	07OCT05	TRN:6S AXL:U2U2AP				

LINE	OPCODE	TECH	TYPE	A/HRS	S/HRS	COST	SALE	COMP	LIST	NET	TOTAL
A C/S PLEASE INSTALL DOOR SILLS (SOP)											
70	TRIM-INTERIOR										
	162	CP	0.00	0.75	1200	7125				71.25	71.25
	1	997-044-800-44	ENTRANCE								
						22690	26094	0	302.53	280.94	260.94
INSTALLED NEW DOOR SILLS											
B C/S PLEASE INSTALL CD PLAYER (SOP)											
27	ENGINE-ELECTRICAL										
	162	CP	0.00	1.50	2400	14250				142.50	142.50
	1	997-044-900-78	CD								
						62129	71448	0	955.85	714.48	714.48
	-1	955-559-037-01-4W9	CHANGER								
						1793	2062	0	35.61	20.62	20.62
	-1	PNA-506-986	LOGO								
						10595	12184	0	189.95	121.84	121.84
	1	911-095-933-20-M7Z	SILVERGUARD CAR COVE								
						1642	1198	0	14.08	11.98	11.98
	1	997-622-712-00	OPTICAL								
						10390	11942	0	155.07	119.42	119.42
INSTALLED CD CHANGER											
C C/S THE NAV UNIT NEEDS TO BE INSTALLED (SOP)											
27	ENGINE-ELECTRICAL										
	162	CP	0.00	0.00	0	0				0.00	0.00
NO WORK DONE PER CLIENT											
B THE CUP HOLDER AREA HAS A RATTLE NOISE, OVER ROUGH ROADS, PLEASE											
CHECK.											
CAUSE: NOISY											
70	TRIM-INTERIOR										
	162	CP	0.00	0.00	0	0				0.00	0.00
	1	997-552-904-02-1MZ	AS								
						51862	47127	0	542.97	471.27	471.27
	1	ZZZ-FRT SHIPPING CHARGE	DASHBOARD								
						0	33.67	0	33.67	33.67	33.67
	1	500-145-011-02	SCREEN M4								
						25	35	0	0.48	0.35	0.35
	X 10										

### STATEMENT OF DISCLAIMER

Any warranties on the parts and/or accessories sold hereby are those made by the manufacturer. The seller, SUNSET IMPORTS, hereby expressly disclaims all warranties either express or implied, including all implied warranties of merchantability or fitness for a particular purpose, and SUNSET IMPORTS neither assumes nor authorizes any other person to assume for it any liability in connection with the sale of these parts and/or accessories.

DESCRIPTION	TOTAL
LABOR AMOUNT	
PARTS AMOUNT	
GAS, OIL, LUBE	
SUBLET AMOUNT	
SHOP SUPPLIES	
TOTAL CHARGES	
LESS INSURANCE	
MISC. CHARGES	
PLEASE PAY THIS AMOUNT	

ALL REPAIRS ARE WARRANTED FOR 12 MONTHS OR 12,000 MILES, WHICHEVER OCCURS FIRST.

CUSTOMER SIGNATURE

87885

66559

# SUNSET IMPORTS

PORSCHE

\*ACCOUNTING\*

4030 S.W. 139th Way  
Beaverton, Oregon 97005  
(503) 841-8600  
(800) 346-0182  
www.sunsetimports.com

PAGE 1

SERVICE ADVISOR: 144 ROB COSNER

COLOR	YEAR	MAKE/MODEL	VIN	LICENSE	MILEAGE IN/OUT	TAG					
GT SILVER	06	PORSCHE 997 C2S	WPOAB29916S740570		128/128	T220					
DEL DATE	FRMO DATE	WARR LINE	FRM/USED	PG NO	PAYMENT	INV DATE					
16SEP05 IS			17:00 22SEP05		0.00 CASH	22SEP05					
R/O OPENED	READY	OPTIONS: STK:2178668 DLR:2040 ENG:3.8_LTR_355_HP									
		TRN:6S AXL:U2U2AP									
22SEP05	22SEP05										
LINE	OPCODE	TECH	TYPE	A/HRS	S/HRS	COST	SALE	COMP	LIST	NET	TOTAL
A PLEASE INSTALL FRONT LICENSE PLATE											
	01	MISCELLANEOUS REPAIR									
	127	CP		0.00	0.00	0	0			0.00	0.00
INSTALLED FRONT PLATE BRACKET											
B PLEASE INSTALL FRONT LENS (CLEAR) (SOP)											
	01	MISCELLANEOUS REPAIR									
	127	CP		0.00	0.00	0	0			0.00	0.00
	1	997-631-033-01 FLASHER									
		LAMP SFL				983	1298	0	16.95	12.98	12.98
	1	997-631-034-01 FLASHER									
		LAMP SFL				983	1298	0	16.95	12.98	12.98
	2	PNA-702-014-00 SATIN									
		FRM CARRERA				4174	5512	0	34.84	27.56	55.12
INSTALLED CLEAR LENSES											
C C/S PLEASE INSTALL CD PLAYER (SOP)											
	01	MISCELLANEOUS REPAIR									
	127	CP		0.00	0.00	0	0			0.00	0.00
PART NOT HERE YET.											
D C/S PLEASE INSTALL SHORT SHIFTER/ 957											
	01	MISCELLANEOUS REPAIR									
	127	CP		0.00	2.00	3430	15000			190.00	190.00
	1	997-424-983-00 SHIFT									
		BRACKET MODULE				36517	43691	0	496.89	439.91	439.91
INSTALLED SHORT SHIFTER.											
E C/S NEEDS TOUCH UP PAINT (SOP)											
	01	MISCELLANEOUS REPAIR									
	127	CP		0.00	0.00	0	0			0.00	0.00
F C/S THE CUP HOLDER RATTLES BADLEY, (WHEN THE CLIENT GRABS IT, - THE											
CAUSE: NPF											
	70	TRIM INTERIOR									
	127	WP		0.00	0.00	0	0			0.00	0.00
						0	0				
						0	0				

### STATEMENT OF DISCLAIMER

Any warranties on the parts and/or accessories sold hereby are those made by the manufacturer. The seller, SUNSET IMPORTS, hereby expressly disclaims all warranties either express or implied, including all implied warranties of merchantability or fitness for a particular purpose, and SUNSET IMPORTS neither assumes nor authorizes any other person to assume for it any liability in connection with the sale of these parts and/or accessories.

ALL REPAIRS ARE WARRANTED FOR 12 MONTHS OR 12,000 MILES, WHICHEVER OCCURS FIRST.

CUSTOMER SIGNATURE

DESCRIPTION	TOTALS
LABOR AMOUNT	
PARTS AMOUNT	
GAS, OIL, LUBE	
SUBLET AMOUNT	
SHOP SUPPLIES	
TOTAL CHARGES	
LESS INSURANCE	
MISC. CHARGES	
PLEASE PAY THIS AMOUNT	

87885

66559

**SUNSET IMPORTS**  
**PORSCHE**

\*ACCOUNTING\*

4030 S.W. 139th Way  
 Beaverton, Oregon 97005  
 (503) 641-8600  
 (800) 348-0182  
 www.sunsetimports.com

PAGE 2

SERVICE ADVISOR: 144 ROB COSNER

COLOR	YEAR	MAKE/MODEL	VIN	LICENSE	MILEAGE IN/OUT	TAG	
GT SILVER	06	PORSCHE 997 C2S	WFOAB29916S740570		128/128	T220	
DEL DATE	PROD DATE	WARR EXP	PROMISED	RD NO	RATE	PAYMENT	INV DATE
16SEP05 IS			17:00 22SEP05		0.00	CASH	22SEP05
H.O. OPENED		READY		OPTIONS: STK:2178668 DLR:2040 ENG:3.8 LTR_355_HP			
22SEP05		22SEP05		TRN:6S AXL:U2U2AP			

LINE	OPCODE	TECH	TYPE	A/HRS	S/HRS	COST	SALE	COMP	LIST	NET	TOTAL
ROAD TEST, COULD NOT DUPLICATE											
G C/S CLEAR BRA TO BE INSTALLED- FRIDAY.											
01 MISCELLANEOUS REPAIR											
	127	CP		0.00	0.00	0	0			0.00	0.00
MISC ENVIRONMENTAL CHARGE											
		CP				0	200			2.00	2.00
CUSTOMER PAY SHOP SUPPLIES FOR RE											
						0	950				9.50

ACCOUNT	SALE	COST	CONTROL	ACCOUNT	SALE	COST	CONTROL
44119	19000	3430		48019	46487	38483	
47169	5512	1174		44129	0	0	
2202	200	0		4421	950	0	
1188	72149		70	73329	0		

**COST, SALE, & COMP TOTALS 46087 72149 0**

**STATEMENT OF DISCLAIMER**

Any warranties on the parts and/or accessories sold hereby are those made by the manufacturer. The seller, SUNSET IMPORTS, hereby expressly disclaims all warranties either express or implied, including all implied warranties of merchantability or fitness for a particular purpose, and SUNSET IMPORTS neither assumes nor authorizes any other person to assume for it any liability in connection with the sale of these parts and/or accessories.

DESCRIPTION	TOTALS
LABOR AMOUNT	190.00
PARTS AMOUNT	519.99
GAS, OIL, LUBE	0.00
SUBLET AMOUNT	0.00
SHOP SUPPLIES	11.50
TOTAL CHARGES	721.49
LESS INSURANCE	0.00
MISC. CHARGES	0.00
PLEASE PAY THIS AMOUNT	721.49

**ALL REPAIRS ARE WARRANTED FOR 12 MONTHS OR 12,000 MILES, WHICHEVER OCCURS FIRST.**

CUSTOMER SIGNATURE

1234

65299

# SUNSET IMPORTS

## PORSCHE

ACCOUNTING

4030 S.W. 139th Way  
Beaverton, Oregon 97005  
(503) 641-8600  
(800) 346-0182  
www.sunsetImports.com

PAGE 1

SERVICE ADVISOR: 144 ROB COSNER

COLOR	YEAR	MAKE/MODEL	VIN	LICENSE	MILEAGE/INT/OUT	TAG	
GT SILVER	06	PORSCHE 997 C2S	WF0AB29916S740570		3/3		
DEL DATE	PROD DATE	WARRANT EXP	PROMISED	PD NO	DATE	PAYMENT	INV DATE
12DEC05 IS			17:00 23AUG05		0.00	CASH	24AUG05
RO OPENED	READY	OPTIONS: STK:2178668 DLR:2040 ENG:3.8 LTR_355_HP					
23AUG05	24AUG05	TRN:6S AXL:U2U2AP					

LINE	OPCODE	TECH	TYPE	A/HRS	S/HRS	COST	SALE	COMP	LIST	NET	TOTAL
PDI PREDELIVERY INSPECTION											
										190.00	190.00
										2.38	2.38
										2.16	2.16

PDI COMPLETED

ACCOUNT	SALE	COST	CONTROL	ACCOUNT	SALE	COST	CONTROL
44159	19000	3000		48719	454	378	
14042	19454	*****	2178668				

**COST, SALE, & COMP TOTALS**      3378    19454    0

**STATEMENT OF DISCLAIMER**

Any warranties on the parts and/or accessories sold hereby are those made by the manufacturer. The seller, SUNSET IMPORTS, hereby expressly disclaims all warranties either express or implied, including all implied warranties of merchantability or fitness for a particular purpose, and SUNSET IMPORTS neither assumes nor authorizes any other person to assume for it any liability in connection with the sale of these parts and/or accessories.

DESCRIPTION	DETAILS
LABOR AMOUNT	0.00
PARTS AMOUNT	0.00
GAS, OIL, LUBE	0.00
SUBLET AMOUNT	0.00
SHOP SUPPLIES	0.00
TOTAL CHARGES	0.00
LESS INSURANCE	0.00
MISC. CHARGES	0.00
PLEASE PAY THIS AMOUNT	0.00

**ALL REPAIRS ARE WARRANTED FOR 12 MONTHS OR 12,000 MILES, WHICHEVER OCCURS FIRST.**

CUSTOMER SIGNATURE

# 2006 Carrera S Coupe

## GT Silver Metallic

### Black Sport Seats

#### Warranty/Durability

10 Year Limited Anti-Corrosion  
Limited 4 Year / 50,000 Mile Warranty-US  
Limited 4 Year / 80,000 KM Warranty-Canada  
Porsche Roadside Assistance

This vehicle is equipped with a front bumper of a type that has been tested at an impact speed of 5 miles per hour, and a rear bumper of a type that has been tested at an impact speed of 5 miles per hour, resulting in no damage to the vehicle's body and safety systems and minimal damage to the bumper and attachment hardware. 'Minimal damage to the bumper' means minor cosmetic damage that can be repaired with the use of common repair materials and without replacing any parts. The stronger the bumper, the less likely the vehicle will require repair after a low-speed collision. This vehicle exceeds the current federal bumper standard of 2.5 miles per hour.

#### Parts Content Information:

For vehicles in this car line:US/Canada parts Content:3%  
Major Sources of Foreign Parts Content: Germany: 58%  
NOTE: Parts content does not include final assembly, distribution, or other non-parts costs.

For this Vehicle : Final Assembly Point:  
Stuttgart-Zuffenhausen, Baden-Wuerttemberg, Germany  
Country of Origin:  
Engine Parts: Germany Manual Transmission: Germany

#### Smog Emissions Information:

The Smog Index of this vehicle is .92

The Smog Index for the average new vehicle is 0.68

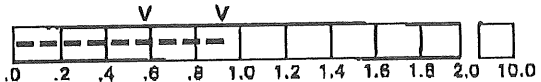

CLEANER <-----> MORE POLLUTING

The Smog Index (SI) indicates the relative level of the smog forming pollutants emitted by the vehicle. The lower the SI, the lower the vehicle's emissions.

THIS LABEL IS AFFIXED PURSUANT TO FEDERAL AUTOMOBILE DISCLOSURE ACT PUBLIC LAW 86-506

Compare this vehicle to others in the FREE GAS MILEAGE GUIDE available at the dealer.

CITY MPG

# 18

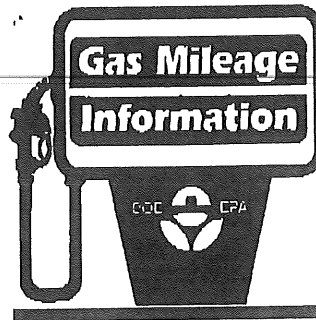

HIGHWAY MPG

# 26

Actual Mileage will vary with options, driving conditions, driving habits and vehicle's condition. Results reported to EPA indicate that the majority of vehicles with these estimates will achieve between

15 and 21 mpg in the city and in between  
22 and 30 mpg on the highway.

2006 Carrera S Coupe  
3.8 L Engine Coupe  
6 Cylinder Fuel Injection  
6 Speed Manual

Estimated Annual Fuel Cost: \$1392

For Comparison Shopping, all vehicles classified as

Minicompact have been issued mileage ratings ranging from

11 to 28 mpg city and  
18 to 36 mpg highway.

See the EPA/DOE website at [www.fueleconomy.gov](http://www.fueleconomy.gov)

Sold-to Dealer 2040  
Sunset Porsche  
4030 S.W. 139th Way  
Beaverton OR 97005

Location..... 5D131  
Meth of Trans.. Truck

## WPOAB29916S740570

Ship-to Dealer 2040  
Sunset Porsche  
4030 S.W. 139th Way  
Beaverton OR 97005

\*\*\*

se  
tsche



Order Reference 2178069

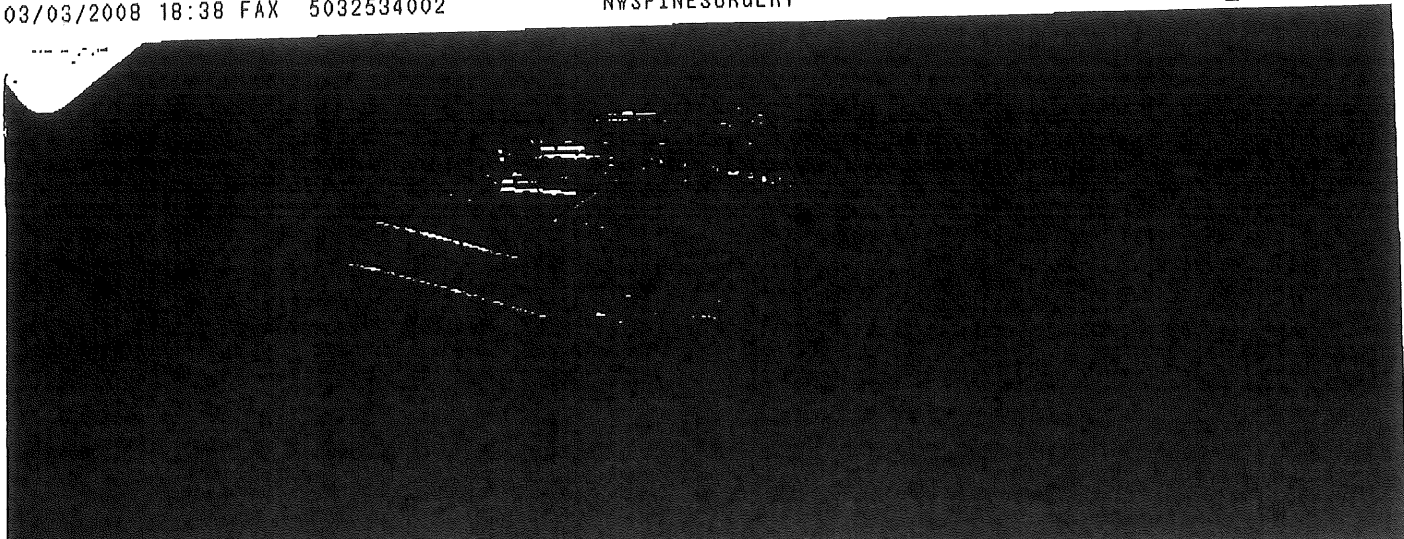

**Technical/Mechanical**  
 Water Cooled, 6 Cyl Engine 3.8 Liters  
 4 Valves/Cylinder, 355 HP  
 Variocam Plus Variable Valve Timing  
 and Lift  
 Integrated Dry Sump Lubrication  
 Cross Flow Cylinder Cooling  
 On-Board Diagnosis System II (OBD II)  
 Cylinder Specific Knock Control w/  
 Dual Knock Sensors  
 6-Speed Manual Transmission  
 Double Inertia Flywheel  
 Hydraulic Clutch  
 Variable ratio power steering  
 Front and Rear Stabilizer Bars  
 295/35 ZR 19" 285/30 ZR 19" Wheels/Tires  
 Speed Activated Rear Spoiler

**Safety/Environment**  
 4-Piston Fixed Alloy Calipers  
 Vented and Perforated Brake Discs  
 Active Brake Differential (ABD)  
 Anti Lock Brakes (ABS)  
 Porsche Stability Management (PSM)  
 Traction Control (ASR)  
 Dual Front Airbags with Porsche Side Impact  
 Protection System (POSIP)  
 Bi-Xenon Lighting System  
 Integrated Third Brake Light

**Comfort/Convenience**  
 Power Windows with One Touch  
 Intermittent Wipers with Rain Sensors  
 Carbon Filtered Ventilation System  
 Illuminated Dual Vanity Mirrors  
 Driver and Passenger Seats with Power  
 Backrest, Manual Height Adjustment  
 Central Locking System  
 Anti-Theft System with Radar  
 Interior Surveillance  
 Lockable Storage Compartment  
 Automatic Full Climate Control with AC  
 Power Heated Side Mirrors  
 Electric Sliding Roof with Tilt  
 Side Windows w/Water Repelling Coating  
 Homelink

Manufacturer's Suggested Retail Price:

Porsche Base Model	81,400
GT Silver Metallic	3,070
GT Silver Metallic Top	N/C
Black Sport Seats	N/C
U.S. Standard/Emissions	N/C
Black Mats - Porsche lettering	115
Adaptive Sport Seats	3,055
Self Dimming Mirrors	385
Heated Front Seats	480
3-Spoke Str Whl Multifctn lthr	740
Wheel Caps with Colored Crest	185
Sport Chrono Package Plus	920
Bose High End Sound Package	1,390
<b>EXCLUSIVE OPTIONS</b>	
Destination Charge	795
<b>TOTAL PRICE*</b>	<b>92,535</b>

Manufacturer's Suggested Retail Price:

\* Gasoline, license and title fees, state and local taxes and dealer installed options and accessories are not included.

\*\*\*\*\*  
**Ask about finance and  
 options available through  
 Financial Services.**

Mazy Hassanpour  
Porsche Specialist



Sunset Porsche  
4030 SW 139th Way  
Beaverton, OR 97005  
Phone: 503-641-8600 Fax: 503-601-3090  
Cellular: 503-989-5119  
Email: mazyhassanpour@sunsetimports.com

2007 Certified  
Sales Professional

- CLEAR BRA
- CONSOLE (SILVER)
- XM RADIO
- SHORT SHIFTER
- NAV
- CD/CHANGER/MP-3
- X-51 HEADERS
- CHROME TAILPIES
- 5mm SPACERS
- 19" TECHART WHEELS
- TRUNK MATS / STORAGE TRAY
- STAINLESS STEEL ENTROPY SILL

Sep 8, 2007

**Wholesale/Retail Breakdown**

**Kelley Blue Book  
Sep-Oct 2007**

2006 Porsche 911 S Coupe 2D..... \$62,000/\$68,400

6-Cyl. 3.8 Liter ..... Included  
6 Speed Manual..... Included  
RWD ..... Included

\*\*\* Equipment \*\*\*

Stability Control.....	Included	Dual Front Air Bags .....	Included
Air Conditioning.....	Included	Front Side Air Bags .....	0/0
Power Steering.....	Included	ABS (4-Wheel).....	Included
Power Windows.....	Included	Traction Control.....	Included
Power Door Locks.....	Included	Leather.....	Included
Telescoping Wheel.....	Included	Dual Power Seats.....	0/0
Cruise Control.....	Included	Power Sun Roof.....	Included
AM/FM Stereo.....	Included	Rear Spoiler.....	100/135
MP3 (Single CD).....	300/400	Premium Wheels 19"+...	800/1,065
Bose Premium Sound.....	250/335	No Cassette.....	0
Navigation System.....	525/700		

Total Value without mileage..... \$63,975/\$71,035  
Mileage adjustment (7,600) miles..... 5,950

\*\*\* Total Wholesale/Retail Value ..... \$69,925/\$76,985

Sunset Imports, Inc.

Sep-Oct 2007 Kelley Blue Book KARPOWER values for Oregon  
Values are subjective opinions. Kelley Blue Book assumes no responsibility for errors or omissions  
© Copyright Kelley Blue Book 2007, all rights reserved

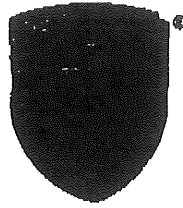

**PORSCHE**

## Certificate of Authenticity

The Porsche vehicle with the identification number listed below was manufactured with the following assembly specifications:

**WPOAB29916S740570**

**Model Year/Type**

2006 911 Carrera S Coupe

**Production Completion Date**

7/14/2005

**Manufacturer's Suggested**

**Retail Price (MSRP)**

USD 91,740.00

**Engine/Transmission Type**

M97/01 / G97/01

**Exterior Paint Color/Code**

GT Silver Metallic Top/U2

GT Silver Metallic/U2

**Interior Material Color/Type**

Black Sport Seats/AR

**Optional Equipment**

Black Mats - Porsche Lettering

U.S. Standard Emissions

Bose High-End Sound Package

Sport Chrono Package Plus

Wheel Caps with Colored Crest

Heated Front Seats

Self-Dimming Mirrors

3 Spoke Steering Wheel

Adaptive Sport Seats

Peter Schwarzenbauer  
President and Chief Executive Officer  
Porsche Cars North America, Inc.